

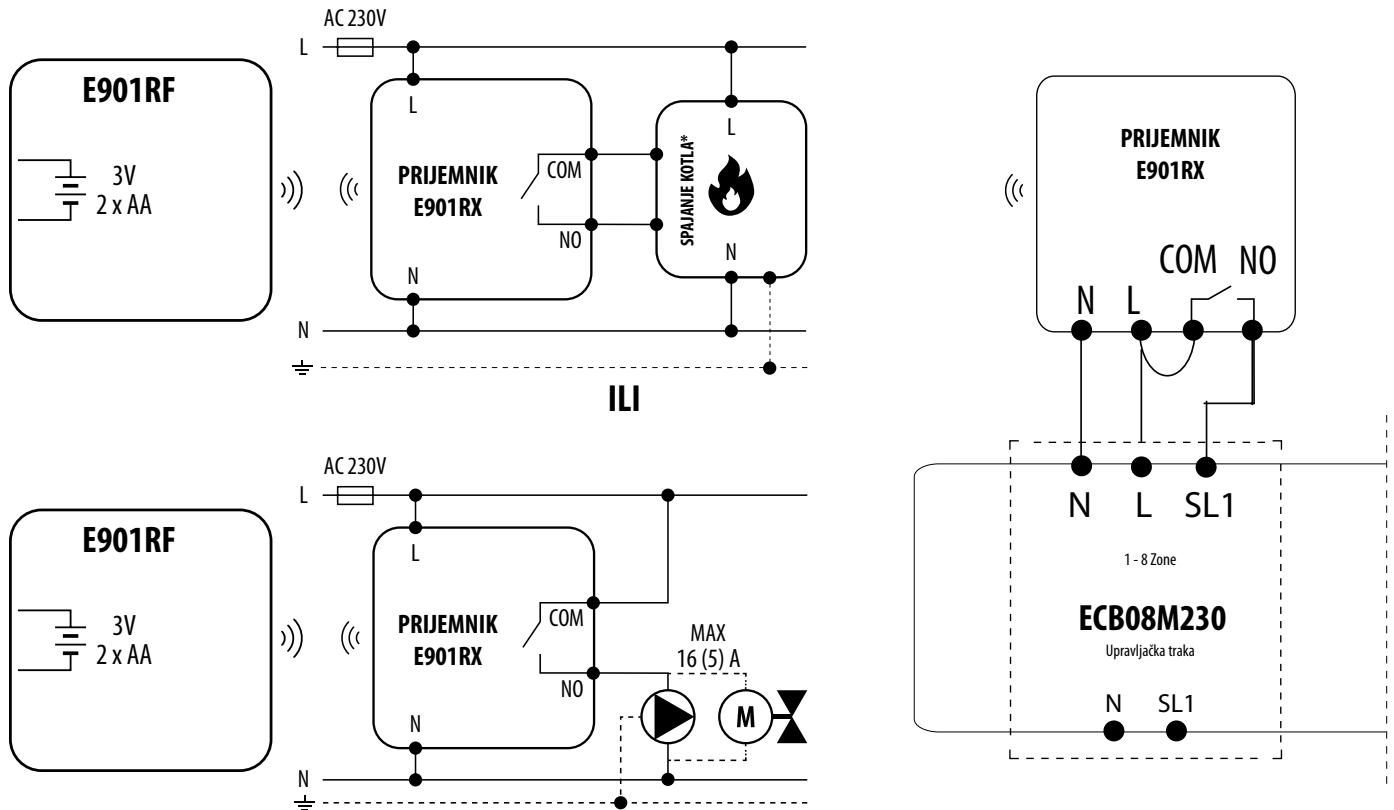





DIJAGRAM POVEZIVANJA - E901RF

Regulator temperature bežični za programiranje



OBJASNJENJA

- | | | | | | |
|--|--|--|------------------------------|---|--------------------------|
|  | Kotao - Spajanje kotla* - Kontakti u kotlu za spajanje regulatora za uključivanje/isključivanje (prema priručniku kotla) |  | Pumpa |  | Aktuator (pogon) ventila |
| L, N | Napon napajanja 230V AC | PE  | Uzemljenje |  | Osigurač |
| COM, NO | Beznaponski izlaz |  | Kontakt otvoren (zatvara se) | | |