

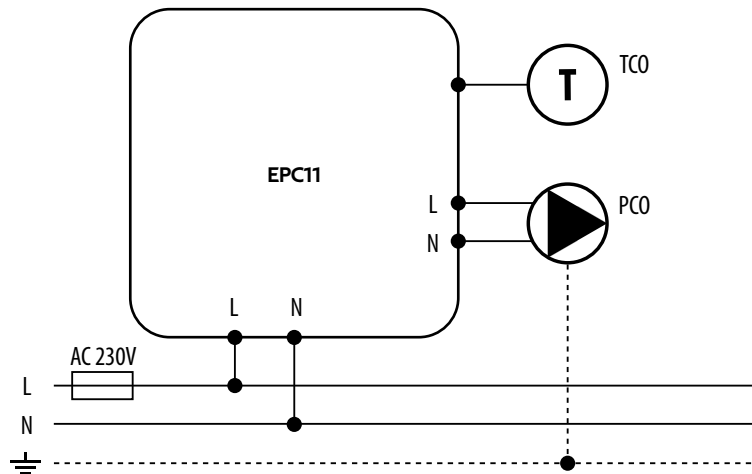









## WIRING DIAGRAM - EPC11

### Pump Controller for CH system



### LEGEND

	Battery powered		Ground (electricity)		Wireless communication
	Fuse		Pump		Heating mode
L, N	230V AC power supply		Valve actuator	S	Occupancy sensor or ON/OFF contact
COM, NO, NC	Voltage-free output		Temperature sensor	S1, S2	Input terminals
	Boiler - Boiler connection * - Boiler's contacts for ON/OFF thermostat (according to the boiler's instructions)		Thermoelectric actuator	SL →	230V AC voltage output