

СХЕМА НА СВЪРЗВАНЕ - EASY230W

Жичен, дневен температурен регулатор

а) Схема на свързване
към газов котел

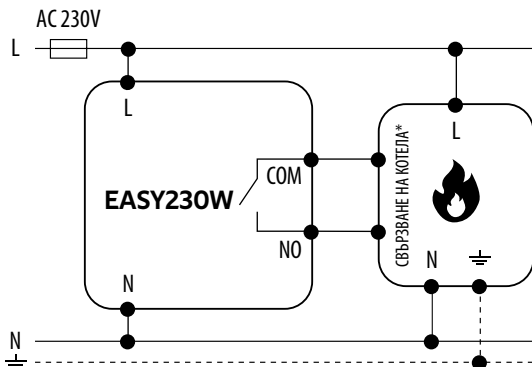



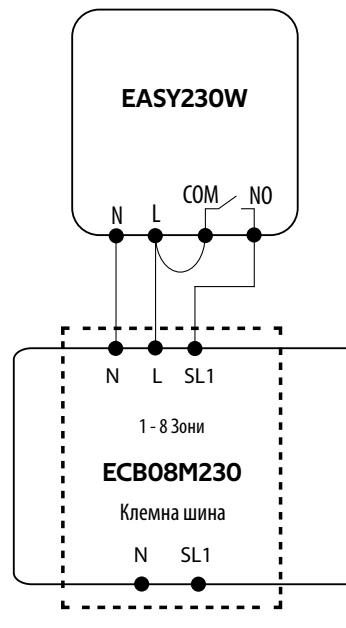



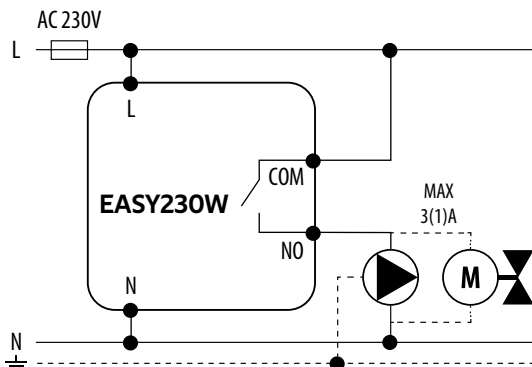





с) Схема на свързване
към клемна шина



б) Схема на свързване към
помпа / задвижка



ЛЕГЕНДА

	Захранване с батерии		Заземяване		Безжична комуникация
	Предпазител		Помпа		Режим на отопление
L, N	Захранващо напрежение 230 V AC		Задвижка на вентила		Превключващ контакт NC/COM/NO
COM, NO, NC	Контакти безнапрежени изходи		Датчик за температура		Нормално отворен контакт
S1, S2	Обозначение на входа		Термоелектрическа задвижка		Нормално затворен контакт
SL →	Напреженов изход 230 V AC		Котел – Свързване на котела* – Контакти в котела за свързване на регулатор ON/OFF (според инструкциите за котела)		