

WIRING DIAGRAM - EASY230B

Non-programmable, wired thermostat,
230V AC powered

a) Connection diagram for gas boiler

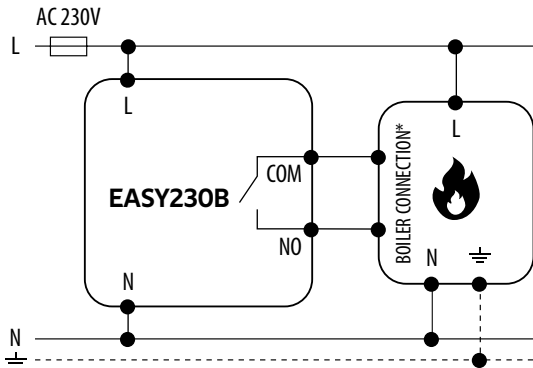



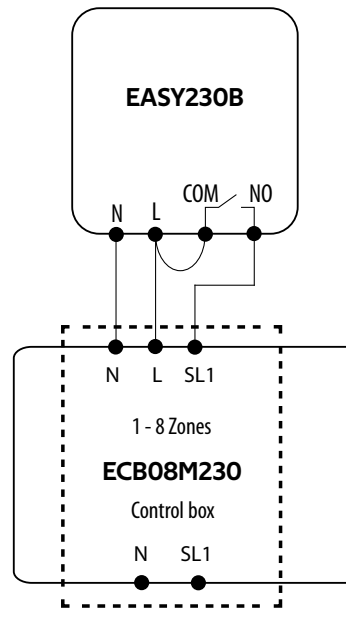



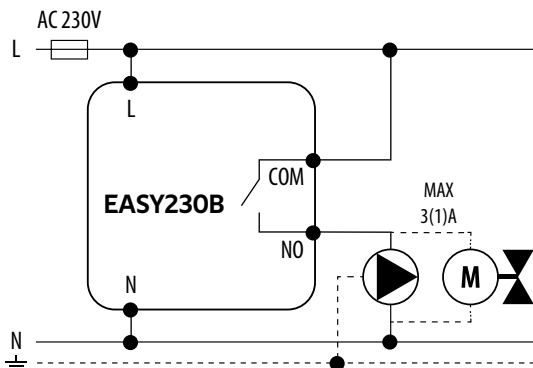





c) Connection diagram to the control box



b) Connection diagram to pump / actuator



LEGEND

	Battery powered		Ground (electricity)		Wireless communication
	Fuse		Pump		Heating mode
L, N	230V AC power supply		Valve actuator		NC/COM/NO switch
COM, NO, NC	Voltage-free output		Temperature sensor		Contact normally open NO
S1, S2	Input terminals		Thermoelectric actuator		Contact normally closed NC
SL →	230V AC voltage output		Boiler - Boiler connection * - Boiler's contacts for ON/OFF thermostat (according to the boiler's instructions)		