

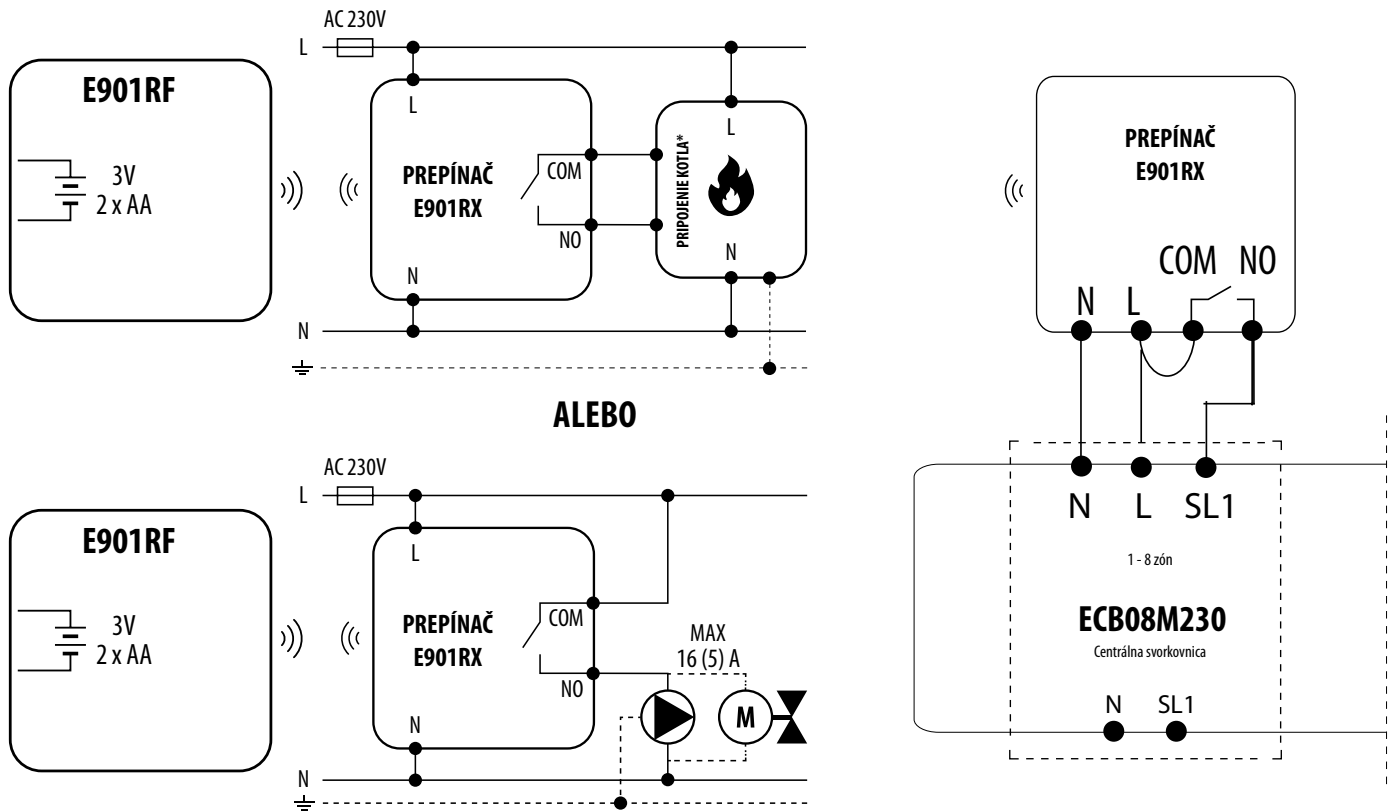





SCHÉMY ZAPOJENIA - E901RF

Bezdrôtový programovateľný termostat



POUŽITÉ SYMBOLY

	Kotol – Pripojenie kotla * – Kontakty kotla pre ON / OFF termostat (podľa inštrukcií kotla)		Čerpadlo		Ovládač ventilu
L, N	Napájanie 230V AC	PE 	Uzemnění		Poistka
COM, NO	Výstup bez napätia		Kontakt je normálne otvorený NO		