

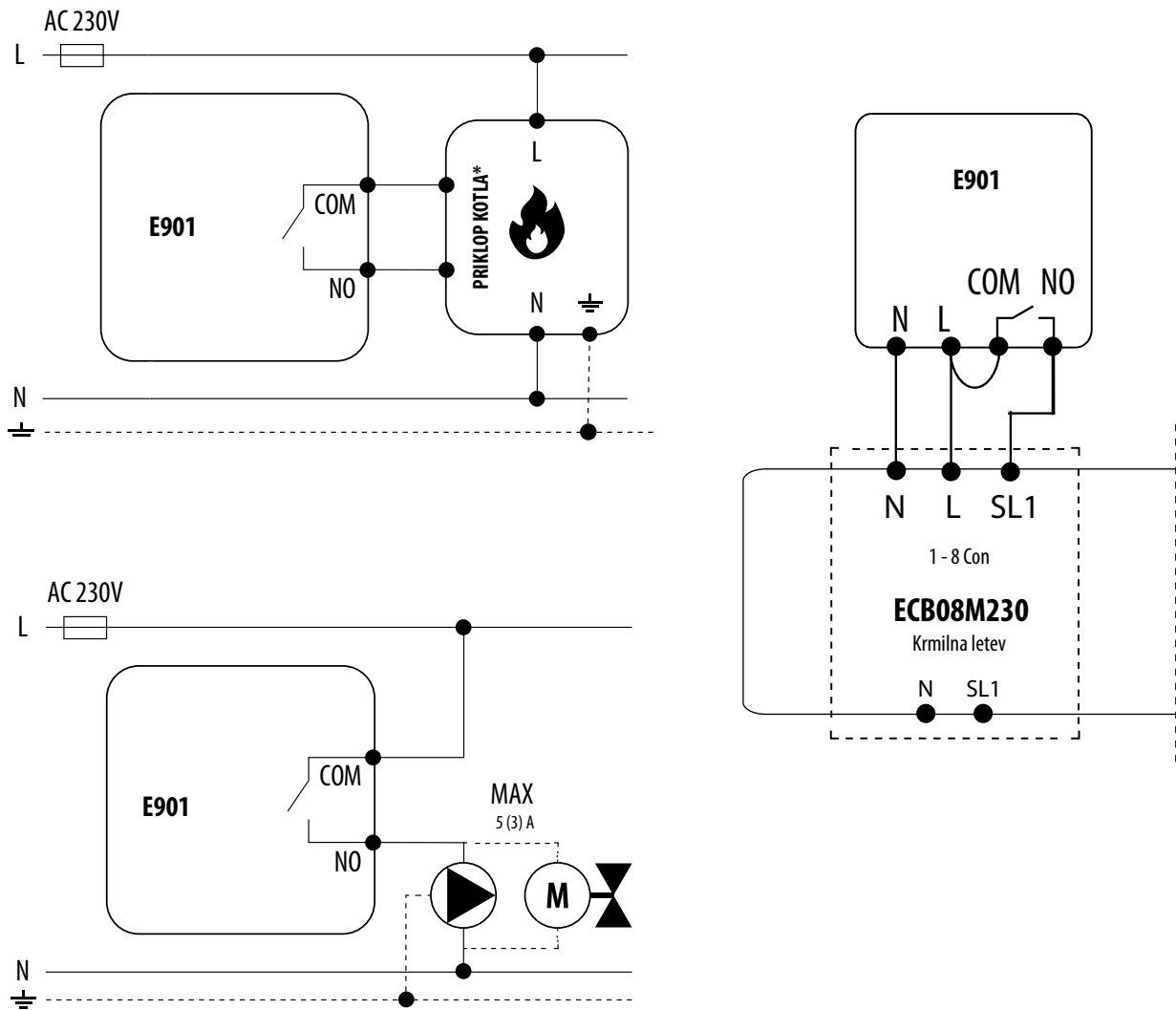





## SHEMA POVEZAVE - E901

### Programabilni, žični regulator temperature



### LEGENDA

	Kotel (priklop kotla*) - kontakti v kotlu za priklop termostata ON/OFF (sladno z navodili za uporabo kotla)		Črpalčka		Pogon ventila
L, N	Napajanje 230V		Ozemljitev		Varovalka
COM, NO	Breznapetostni izhodni kontakti		Navadno odprti kontakt		