

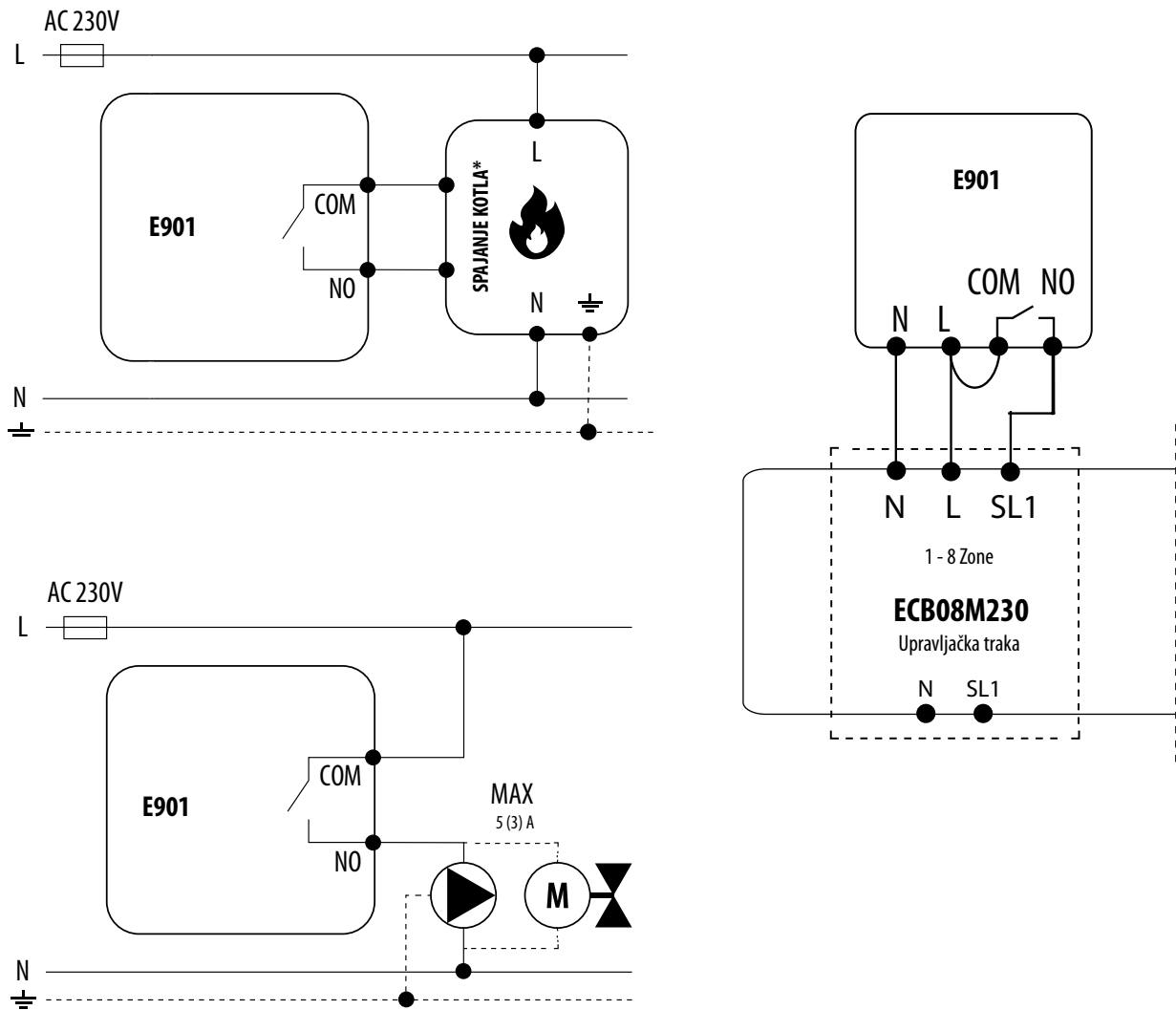





DIJAGRAM POVEZIVANJA - E901

Regulator temperature žičani za programiranje



OBJASNJENJA

	Kotao - Spajanje kotla* - Kontakti u kotlu za spajanje regulatora za uključivanje/isključivanje (prema priručniku kotla)		Pumpa		Aktuator (pogon) ventila
L, N	Napon napajanja 230V AC		Uzemljenje		Osigurač
COM, NO	Beznaponski izlaz		Kontakt otvoren (zatvara se)		