

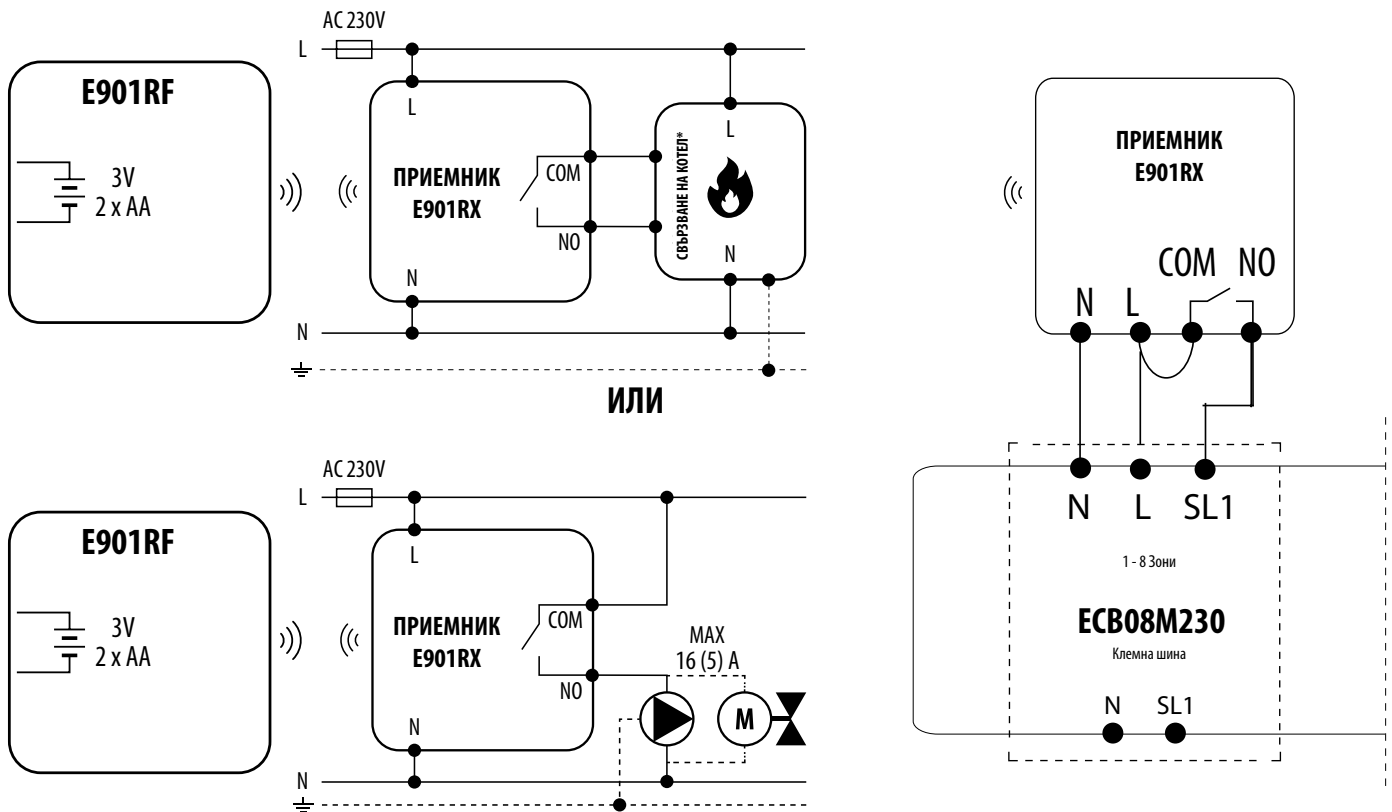





СХЕМА НА СВЪРЗВАНЕ - E901RF

Безжичен регулатор на температура



ЛЕГЕНДА

- | | | | | | |
|--|---|--|--------------------------|---|---------------------|
|  | Котел – Свързване на котела* – Контакти в котела за свързване на регулатор ON/OFF (според инструкциите за котела) |  | Помпа |  | Задвижка на вентила |
| L, N | Захранващо напрежение 230 V AC | PE  | Заземяване |  | Предпазител |
| COM, NO | Контакти безнапрежени изходи |  | Нормално отворен контакт | | |