

E901WIFI | Wireless, Internet Thermostat, Wi-Fi

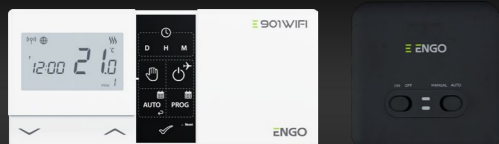

E901TXWIFI

E901RXWIFI

Ver. 5
Release date: XI 2023

Quick Guide



Producer:
Engo Controls S.C.
43-262 Kobilice
4 Rolna St.
Poland

Distributor:
QL CONTROLS Sp z o.o. Sp. k.
43-262 Kobilice
4 Rolna St.
Poland

www.engocontrols.com

INTRODUCTION:

E901WIFI is a wireless, Wi-Fi room thermostat which enables economical and ecological control of any type of heating. The operation of the thermostat is very simple and allows the user to adjust the heating cycle to user's rhythm of the day. Built-in WiFi module (in the receiver) enables remote control of the heating system via a smartphone or a tablet using the ENGO application Smart / TUYA Smart. The devices are pre-paired and ready for work.

Product Compliance

This product complies with the following EU Directives: 2014/53/EU, 2016/65/EU (9) 868.0 MHz - 868.6 MHz; <13dBm WiFi 2,4 GHz

Please note!

This document is a brief manual of the installation and operation of the product and highlights its most important features and functions.

SAFETY INFORMATION:

Use in accordance with national and EU regulations. Use the device only as intended, keeping it in a dry condition. The product is for indoor use only. Please read the entire manual, before installation or use.

INSTALLATION:

Installation must be performed by a qualified person with appropriate electrical qualifications, in accordance with the standards and regulations in force in a given country and in the EU. The manufacturer is not responsible for non-compliance with the instructions.

WARNING:

For the entire installation, there may be additional protection requirements, which the installer is responsible for.

Care for the natural environment is of paramount importance to us. The awareness that we manufacture electronic devices obliges us to dispose of used electronic components and devices safely. Therefore the company has received a registration number issued by the Chief Inspector for Environmental Protection. The crossed out symbol the trash can on the product means that the product must not be disposed of with ordinary waste containers. Sorting waste for recycling helps to protect the environment. It is the user's responsibility to surrender used equipment to a designated collection point for recycling waste from electrical and electronic equipment.

Wall mounting



Remove the thermostat cover as shown in the picture. If there are batteries inside, remove them



Use a screwdriver to push the plastic tabs in as shown in the figure until you feel resistance, and tilt the front part of the housing.



Separate the front part from the back part in the direction shown above

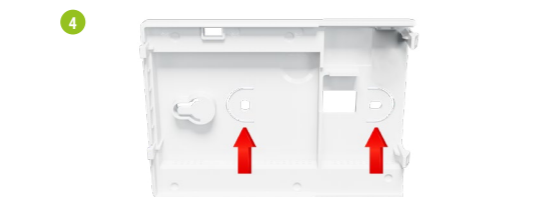

Use the supplied mounting screws and mount the back cover to the wall (use holes as shown arrows)



Using the hinges on the left, fold the front and back covers together as shown in the picture above until they click into place.

Wiring Diagrams

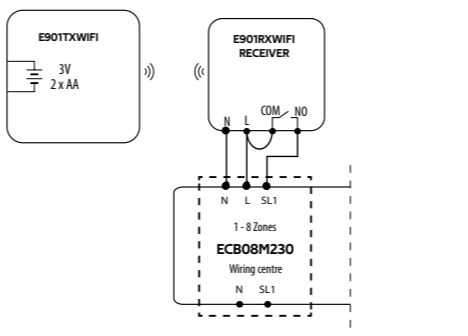
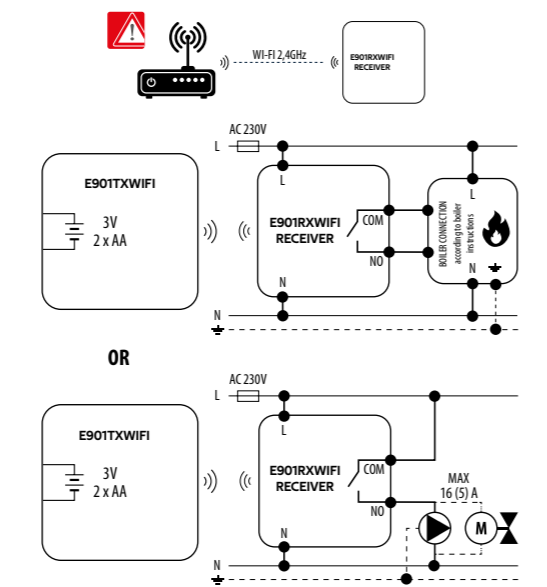

E901RXWIFI receiver

Receiver's switches description:

LEFT SWITCH	
1.	ON - Manual mode - receiver ON
2.	OFF - Manual mode - receiver OFF
RIGHT SWITCH	
3.	MANUAL - Receiver works in manual mode (according to the left switch)
4.	AUTO - Receiver works in AUTO mode (according to the thermostat's command)

LED indications in the receiver

The status of the receiver is indicated by two LEDs. These are LEDs with the following colors:

1	- red (upper one), - green (upper one), - blue (upper one), - pink (upper one),
2	- orange (lower one).

A detailed explanation of the meaning of the LEDs can be found in the table below:

	DESCRIPTION
The red LED flashes	The red LED diode flashes - Receiver and thermostat are prepared for installation in the app. LED always flashes red: - immediately after connecting the receiver to the power supply, if the thermostat is not added to the app - after running the parameter "APP" -> YES (installer parameters) - after removing thermostat from the app (device automatically entered pairing mode)
The red LED steady	The red LED diode is steady - E901 WIFI has not been installed in the app and it is working in Offline mode. It means also app pairing mode timed out (pairing with app must be done within 10 minutes after enabling pairing mode).
The green LED is solid	The receiver is connected to a router but there is no connection to Internet (router is offline)
The green LED flashes	The receiver lost connection with a router (router is off)
The blue LED is solid	The receiver is connected to a router that has Internet access (router is online)
The blue LED flashes	The receiver was paired but lost communication with the thermostat due to out of range or low battery in the thermostat. When receiver lost communication with thermostat it starts flashing after 15 minutes.
The orange LED is solid	In automatic mode, the receiver received a heating / cooling signal from the thermostat or the receiver was started in manual mode (left switch ON, right switch MANUAL)
The orange LED flashes	The receiver is in the pairing mode and is looking for a signal from the thermostat (then you must activate the "SYNC" parameter in the thermostat).
The orange LED is off	The receiver does not send a heating / cooling signal.
The pink LED is on	Update process started. To increase the chance of success of the update - immediately after the pink diode appears, click any thermostat's button to turn on backlight

LCD icon description

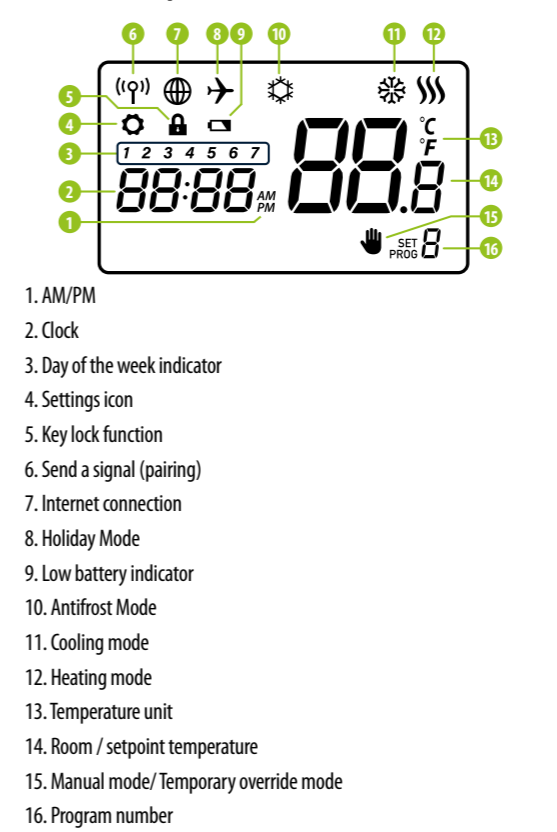

1. AM/PM
2. Clock
3. Day of the week indicator
4. Settings icon
5. Key lock function
6. Send a signal (pairing)
7. Internet connection
8. Holiday Mode
9. Low battery indicator
10. Antifrost Mode
11. Cooling mode
12. Heating mode
13. Temperature unit
14. Room / setpoint temperature
15. Manual mode/ Temporary override mode
16. Program number

Button description

Button	Function
∨	Change the parameter value down
∧	Change the parameter value up
D	Set the day of the week
H	Set the hour
M	Set the minutes
Hand icon	Manual mode
Power icon	OFF mode / Holiday mode
AUTO icon	AUTO mode / Back button
PROG icon	Programming / Program selection
✓	Confirm function
• Reset	Thermostat reboot, time reset

Setting Time / Setting Date

In the online mode - the thermostat reads the current time from the application. In the offline mode - D/H/M buttons are active and day/time can be set manually

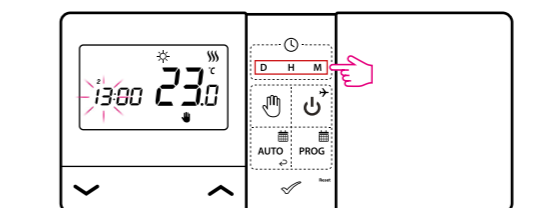

- D** - Press D button to set the day
- H** - Press H button to set the hour.
- M** - Press M button to set the minutes.

Manual mode - temperature settings

In manual mode, the thermostat maintains a constant setpoint temperature as long as the user will not change it again or will not switch to another operating mode (e.g. schedule mode).

Setting setpoint temperature in manual mode

Press any button to highlight the screen, then follow the steps below:

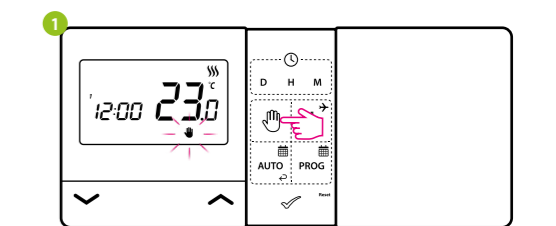

Press button to enter manual mode. The hand icon should be visible on the display.

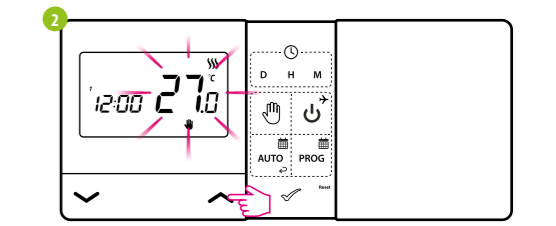

Using button set new comfort temperature value.

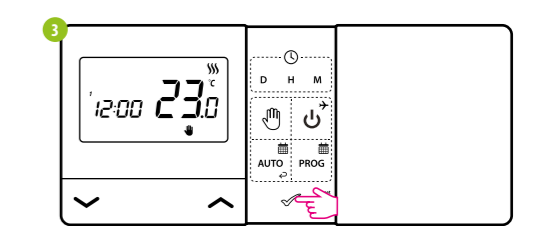

Confirm by button or wait until the thermostat will approve your choice itself and display the main screen.

OFF mode

Press any button to highlight the screen, then follow the steps below:

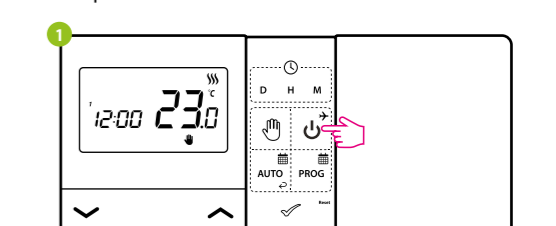

Press button to enter OFF mode.

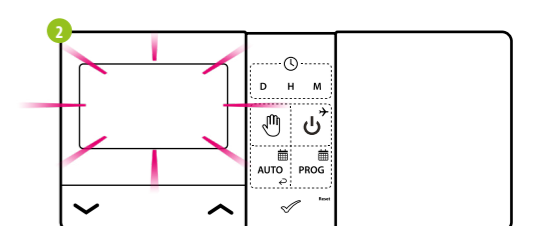

LCD is turned OFF, Thermostat is not sending signal for heating/cooling to the receiver.

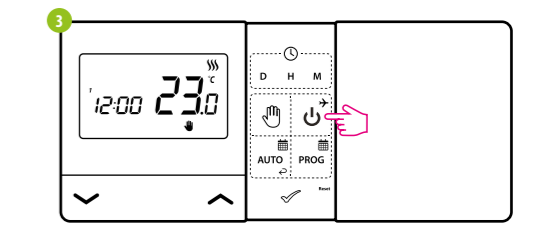

To exit the OFF mode press again the button. The thermostat will return to the previous mode.

Installation of the E901WIFI thermostat in the app

Make sure your router is within range of your smartphone. Make sure you are connected to the Internet. This will reduce the pairing time of the device. Use only Wi-Fi 2,4GHz network

STEP 1 - DOWNLOAD ENGO SMART APP

Download the ENGO Smart app from Google Play or Apple App Store and install it on your smartphone.



STEP 2 - REGISTER THE NEW ACCOUNT

To register a new account, please follow the steps below:

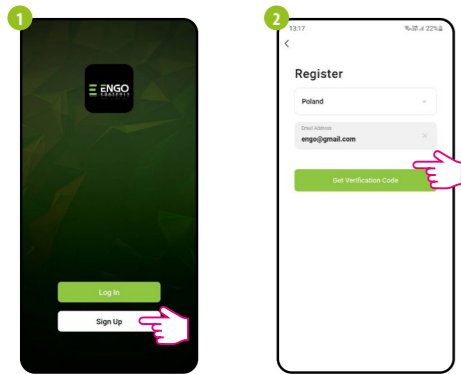

Click „Register“ to create new account.

Enter your e-mail address to which the verification code will be sent.

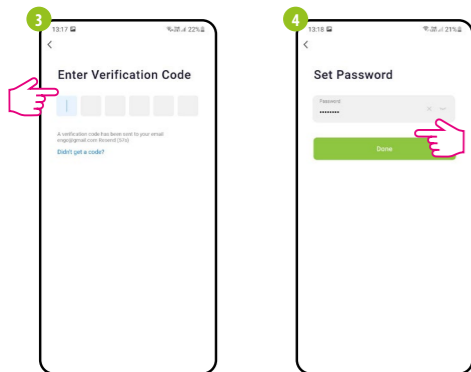

Enter the verification code received in the email.

Remember that you only have 60 seconds to enter the code!

Then set the login password.

STEP 3 - CONNECT THE THERMOSTAT TO WI-FI

1 After installing the app and creating an account:

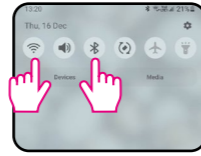

Turn on Wi-Fi and Bluetooth on your smartphone. Connect mobile phone to the Wi-Fi network to which you want to assign the thermostat.

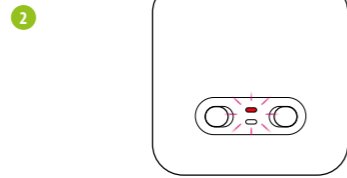

2 Connect the receiver to the power supply. When first powered up, the red led will start flashing, which means that devices are ready to be added to the application. Go to step 7 (adding devices in the app).

If the red LED on the receiver is not flashing, proceed with the next steps.

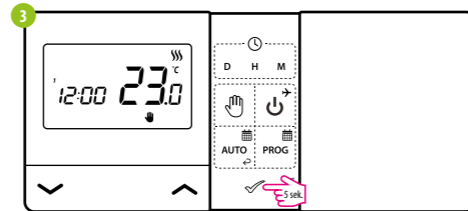

Press and hold ✓ button for 5 seconds.

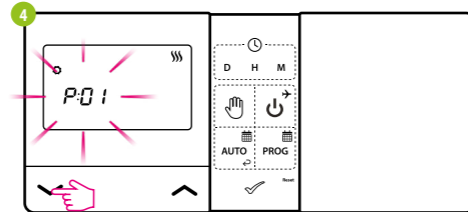

Use ^ or v button to choose APP - add to application parameter.

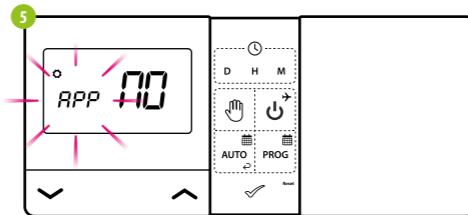

Confirm with ✓ button.

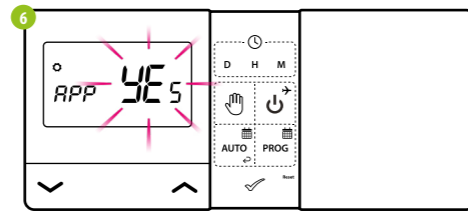

Use ^ or v button to choose YES and confirm with (OK) button to start the process of adding to the application. ✓



In the app, select: „Add Device“.

Then choose: „Auto Scan“.

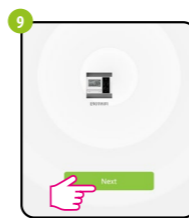

9 After finding the thermostat, go „Next“.



Select the Wi-Fi network which thermostat should connect and put its password.

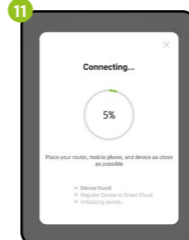

11 Wait for the app to configure thermostat.

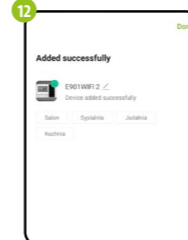

12 Name the device and click „Done“.

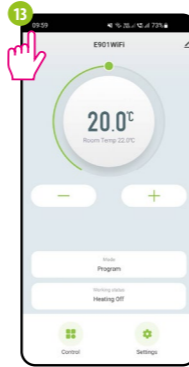

13 Thermostat has been installed and displays the main interface.



14 ...and it shows on the main app window.

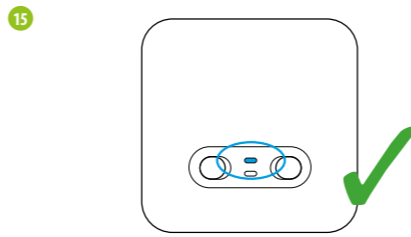

15 When the blue LED on the receiver will light up, it means the device has been correctly added to the application and is now connected to the Internet.

E901WIFI pairing process with the receiver

PLEASE NOTE!
E901WIFI THERMOSTAT IS ALREADY PAIRED WITH THE RECEIVER!

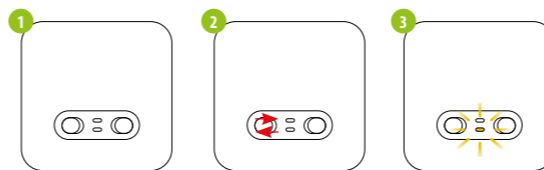

If you want to re-pair the receiver and thermostat with each other and then add it to the application, make sure that the receiver is disconnected from the power supply, and the switches on it are in the ON and AUTO positions. Then connect the receiver to the power supply and wait a few seconds. Next, move the left switch to the OFF position and back to the ON position with a quick motion. The orange LED will start blinking, which will confirm that the receiver has entered the pairing mode.

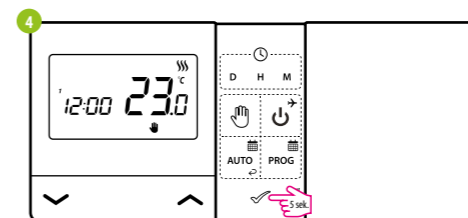

4 Press and hold the ✓ button for 5 seconds.

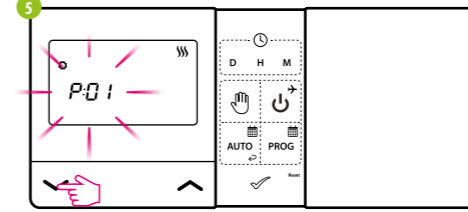

5 Use ^ or v button to select SYNC parameter.

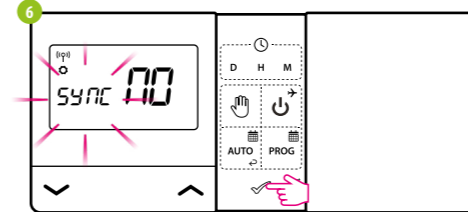

6 Confirm with ✓ button.

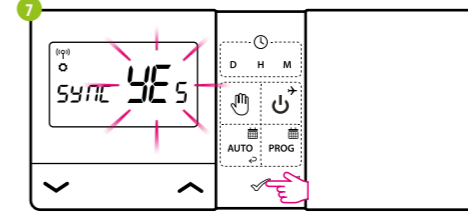

7 Using ^ or v buttons choose YES and start the pairing process on a new frequency by pressing the button ✓.

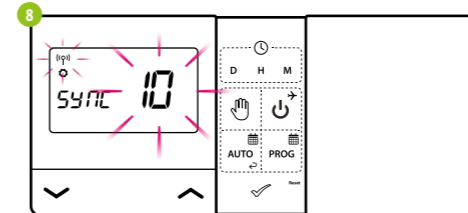

8 The thermostat started to send a signal to find the receiver (the symbol of the blinking antenna) and started the countdown with the number 10 (min). The pairing process may take up to 10 minutes.

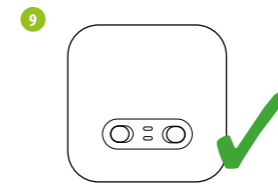

9 When the orange LED stops blinking, the devices have been paired on a new frequency.

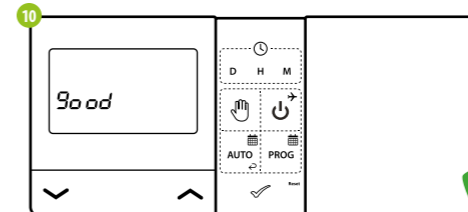

The thermostat will display the message „good“, which means that the devices are successfully paired with each other. Thermostat will return to the next APP parameter in the service menu (adding to application). You can skip this step and return to the main menu by clicking (OK) button a few times ✓

WARNING! If the orange LED on the receiver has not stopped blinking after 10 minutes, repeat the pairing process taking into account the distance between devices, obstacles and interference.

Installer settings

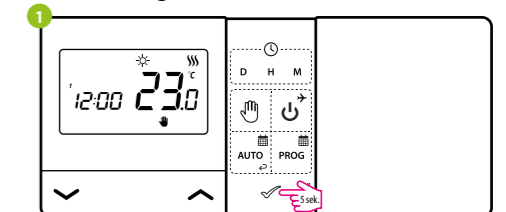

1 To enter installer parameters press and hold ✓ button for 5 seconds.

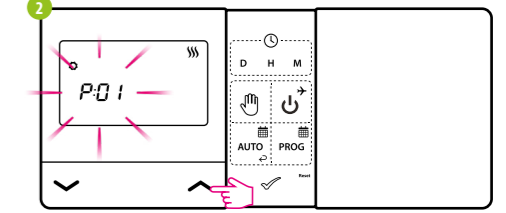

2 Use ^ or v button to move between parameters. Enter the parameter by ✓. Edit the parameter using ^ or v. Confirm the new parameter value with the ✓ button.

Installer parameters

Pxx	Function	Value	Description	Default value
P01	Heating/Cooling Selection	☀	Cooling	☀
		☾	Heating	
P02	Control algorithm	1	SPAN ±0,25°C	1
		2	SPAN ±0,5°C	
		3	TPI for Underfloor Heating	
		4	TPI for Radiators	
		5	TPI for Electrical Heating	
P03	Offset temperature	-3.5°C to +3.5°C	If the thermostat indicates wrong temperature, you can correct it by ±3.5°C	0°C
P04	Relay type	NO	Normally Open type of relay	NO
		NC	Normally Closed type of relay	
P05	Clock format	24h	24 hour	24h
		12h	12 hour	
P06	Minimum setpoint	5°C - 20°C	Minimum heating / cooling temperature that can be set	5°C
P07	Maximum setpoint	20°C - 35°C	Maximum heating / cooling temperature that can be set	35°C
P08	Key sound	NO	Key sound Off	YES
		YES	Key sound On	
P09	PIN Code	NO	Disabled	NO
		PIN	Enabled	
P10	Require a PIN to unlock the keys every time	NO	Function disabled	YES
		YES	Function enabled	
SYNC	Pairing with receiver function	NO	Function disabled	NO
		YES	Function enabled	
APP	Pairing with application function	NO	Function disabled	NO
		YES	Function enabled	
CLR	Clear settings factory reset	NO	No action	NO
		YES	Factory Reset	

Technical specification

Thermostat supply	2 x AA batteries
Receiver supply	230 V AC 50 Hz
Receiver rating max	16 (5) A
Receiver outputs	Voltage-free NO/COM relay
Temperature range	5 - 35°C
Control algorithm	TPI or Hysteresis (±0.25°C or ±0.5°C)
Communication	Wireless, 868 Mhz + WIFI 2,4 GHz
Dimensions [mm]	thermostat: 150 x 84 x 22 receiver: 96 x 96 x 27