

E901 | Programmable, wired thermostat

FULL MANUAL

TABLE OF CONTENTS

1. Introduction	3
1.1 Product Compliance	3
1.2 Safety Informations	3
2. Product Overview	4
2.1 Package content	5
2.2 Proper thermostat location	5
2.3 Wall mounting	6
3. Connection description	7
4. Before you start (first power on)	8
4.1 LCD icon description	9
4.2 Button description	9
5. Time settings	10
6. Operation	11
6.1 Manual mode	11
6.1.1 Comfort mode	11
6.1.2 Economic mode	12
6.2 AUTO mode - schedule type 1	13
6.2.1 Default program settings (1-3)	13
6.2.2 Choosing and programming (4-9) user programs	14
6.2.3 Frost Protection program setting	16
6.2.4 Temporary overwrite mode	17
6.3 AUTO mode - schedule type 2	18
6.3.1 Switching between AUTO types 1 and 2	18
6.3.2 Programming method of the AUTO mode - type 2	19
6.3.3 Temporary overwrite mode	20
6.4 Party mode	21
6.5 Holiday mode	22
7. Installer settings	23
8. User settings reset	25
9. Clear settings - factory reset	25
10. Cleaning and Maintenance	26
11. Technical Informations	26
12. Warranty	27

1. Introduction

1.1 Product Compliance

This product complies with the essential requirements and other relevant provisions of Directives 2014/53/EU and 2011/65/EU.

1.2 Safety Informations

- Before starting installation work and before using the product, read the entire manual.
- The information contained in the instructions is essential for proper functioning.
- To avoid accidents resulting in personal injury and material damage, please follow all safety precautions, specified in this manual.
- The device should not be used by people with limited mental, sensory or mental abilities, without experience, of insufficient knowledge as well as children.
- Do not use an unassembled device (eg without a cover).
- The device may only be opened by a qualified person.
- Keep electrical devices out of the reach of children and ensure that they do not play with it. Children should not be left unattended. If necessary, disconnect the control system for the entire room.
- Do not leave the packaging, cabinet, or any loose parts of the device unattended, as they pose a risk to children.

WARNING!

- Installation must be carried out by a qualified person with appropriate electrical qualifications in accordance with standards and regulations in force in the given country and in the EU.
- Never try to connect the device other than as described in the manual.
- Before assembly, repair or maintenance as well as during any connection works it is absolutely necessary disconnect the mains supply and make sure that the terminals and electric wires are not live.
- The device may not be exposed to extreme temperatures, strong vibrations or subjected to mechanical shock.
- The device should not be used in unfavorable environmental conditions or in rooms where there is a concentration of flammable gases, fumes or dust.

WARNING!

- There may be additional protection requirements for the entire installation that the installer is responsible for maintaining.



Care for the natural environment is of paramount importance to us. The awareness that we manufacture electronic devices obliges us to dispose of used electronic components and devices safely. Therefore the company has received a registration number issued by the Chief Inspector for Environmental Protection. The crossed out symbol the trash can on the product means that the product must not be disposed of with ordinary waste containers. Sorting waste for recycling helps to protect the environment. It is the user's responsibility to surrender used equipment to a designated collection point for recycling waste from electrical and electronic equipment.

2. Product Overview

E901 is a programmable, surface-mounted electronic room thermostat, used for wireless control of heating devices (e.g. gas, oil boilers, heat pumps) or cooling devices. It has the function of creating your own schedules. Thanks to the built-in algorithms, it offers much better temperature control accuracy than traditional mechanical thermostats. Please read these instructions carefully before using the device for the first time. The thermostat should use AA, 1.5V alkaline batteries. Put the batteries in the battery compartment located under the slide cover. Rechargeable batteries are not allowed.

Product features:

- has 2 types of time schedules
- possibility to choose hysteresis or built-in TPI algorithm
- maximum / minimum temperature limitation
- two relay types (selectable in thermostat settings): NO (normally open) or NC (normally closed)
- has the HEATING / COOLING modes
- PIN lock

2.1 Package content

- 1) E901 thermostat
- 2) Short instruction
- 3) 2xAA batteries
- 4) Mounting screws

1



E901 thermostat

2



Short manual

3



2xAA batteries

4



Mounting screws

2.2 Proper thermostat location

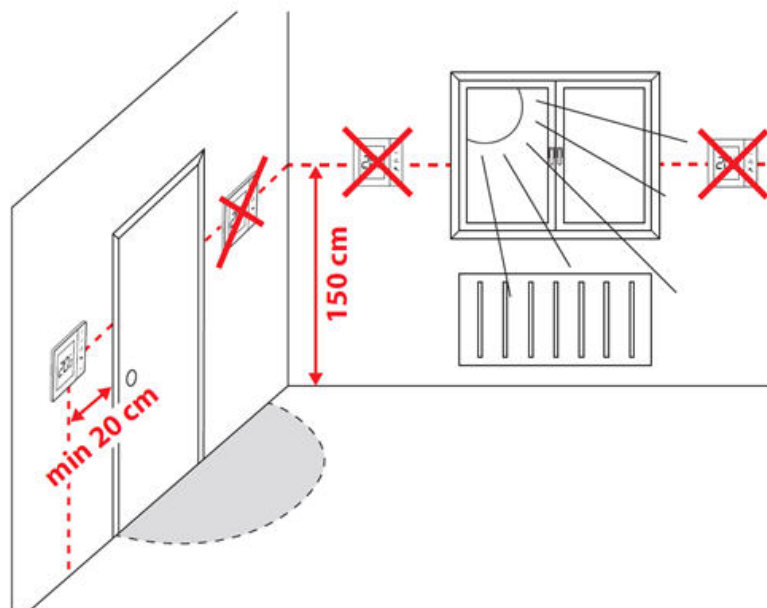

Please note:

The ideal position to thermostat mounting is about 1,5m under floor level far from heating or cooling sources. Thermostat can't be exposed to sunlight or any extreme conditions like for example draft.

Because of fire and explosion risk there is not allowed to use thermostat in atmosphere of explosive gases and flammable liquids (eg coal dust). In case if any of listed dangers occur you have to use additional protection measures – anti-dust and explosive gases (tight cover) or prevent their formation. Furthermore, thermostat can't be used in condensation of water vapor conditions and be exposed to water action.

2.3 Wall mounting



Remove the thermostat cover as shown in the picture. If there are batteries inside, remove them.



Use a screwdriver to push the plastic tabs in as shown in the figure until you feel resistance, and tilt the front part of the housing.



Separate the front part from the back part in the direction shown above.



Then fix the back cover to the wall using the supplied mounting screws and the holes provided (see bigger arrows). Connect the wires to the COM / NO connector (see smaller arrows).



Using the hinges, fold the back and front covers by moving as shown in the picture above.

3. Connection description

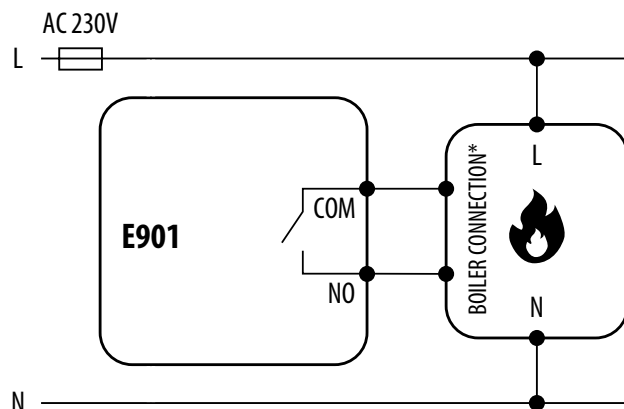

OR

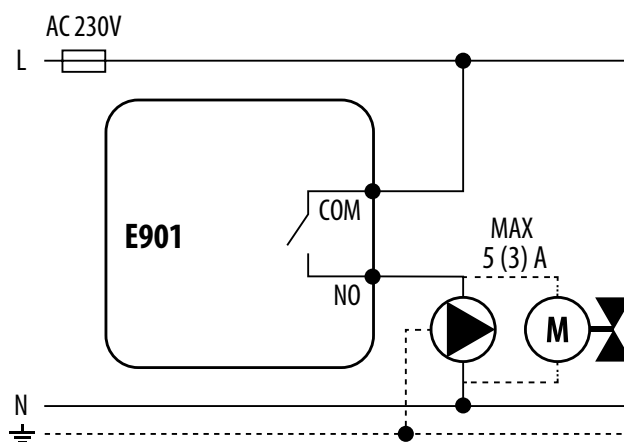

Legend:



Boiler - Boiler connection*
- Boiler's contacts for ON/OFF thermostat (according to the boiler's instructions)



Pump



Valve actuator

Symbols explanation:

L, N - power supply 230V

COM, NO - voltage-free output

 - fuse

4. Before you start (first power on)

The thermostat is powered by two 1.5V AA alkaline batteries. Insert the batteries into the compartment under the front housing, paying attention to their polarity. The thermostat will start up showing the current software value and then go to the main screen.

1

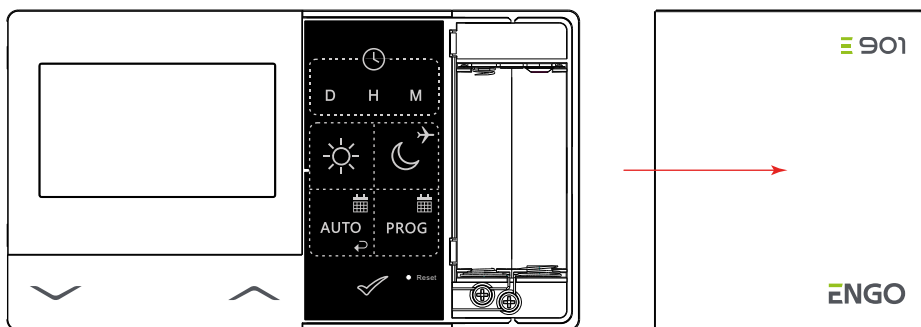

PULL OFF THERMOSTAT SLIDE COVER.

2

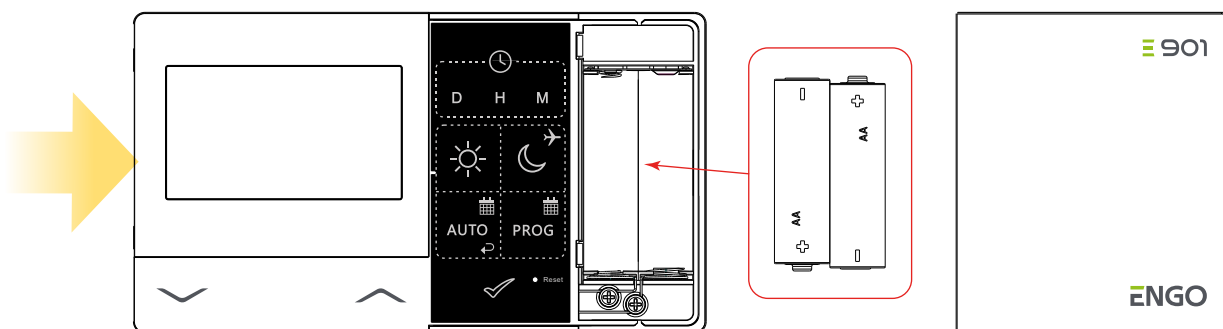

INSERT THE BATTERIES, PAYING ATTENTION TO THEIR POLARITY!

3

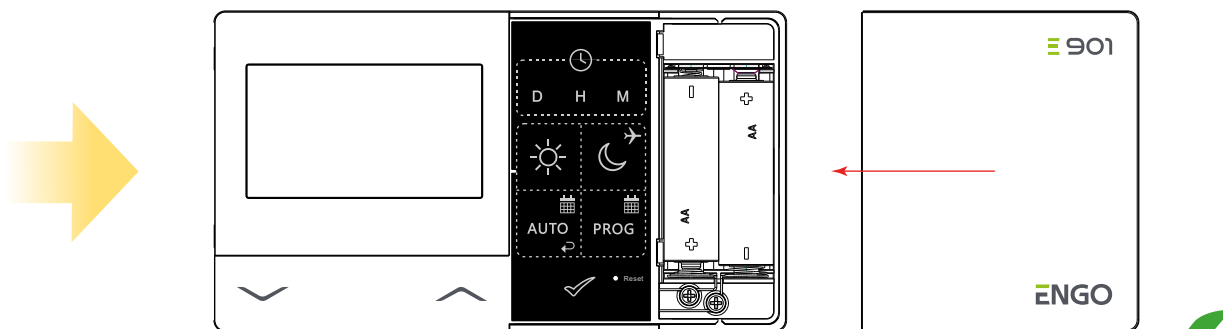

PLACE AND SLIDE THERMOSTAT FRONT HOUSING.
THE LCD WILL TURN ON WHEN THE BATTERIES ARE INSERTED.

4.1 LCD icon description

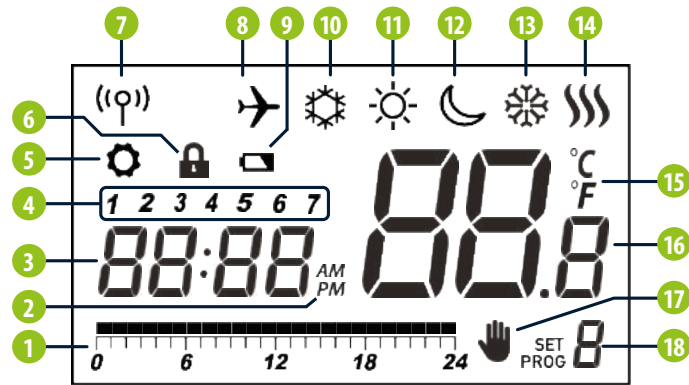

- | | |
|---|---------------------------------|
| 1. Program timeline indicator | 10. Frost Protection Mode |
| 2. AM/PM | 11. Comfort Mode |
| 3. Clock | 12. Economic Mode |
| 4. Day of the week indicator | 13. Cooling status |
| 5. Settings icon | 14. Heating status |
| 6. Key lock function | 15. Temperature unit |
| 7. Send a signal (pairing)* only E901RF | 16. Room / setpoint temperature |
| 8. Holiday Mode | 17. Temporary override |
| 9. Low battery indicator | 18. Program number |

4.2 Button description

Button	Function
∨	Change the parameter value down
∧	Change the parameter value up
D	Set the day of the week
H	Set the hour
M	Set the minutes
☀	Comfort temperature
☾	Economic temperature / Holiday mode
AUTO	AUTO mode / Back button
PROG	Programming / Programming type selection
✓	Confirm button
• Reset	Factory Reset

5. Time settings

In this chapter you will learn how to set the time on the thermostat using the D, H and M buttons. To do this, see the steps below:

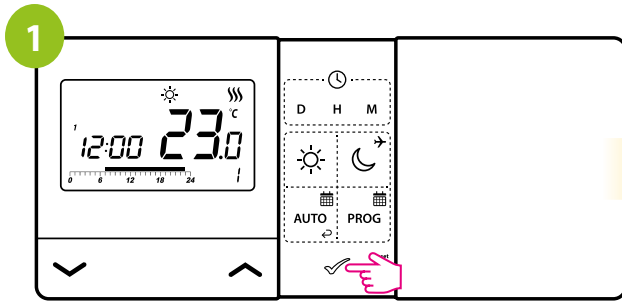

Press any button to highlight the display.

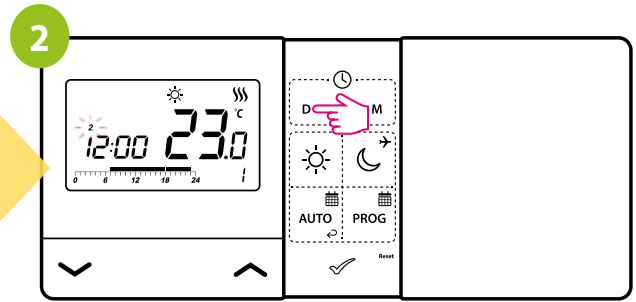

Pressing D button set the day.

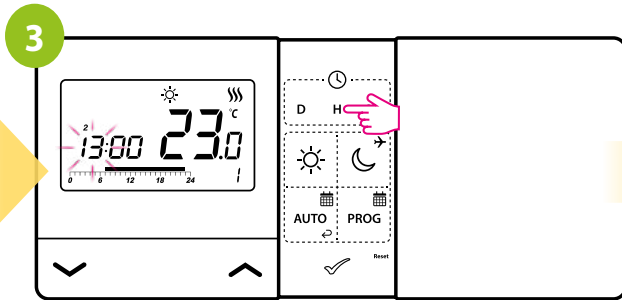

Pressing H button set the hour.

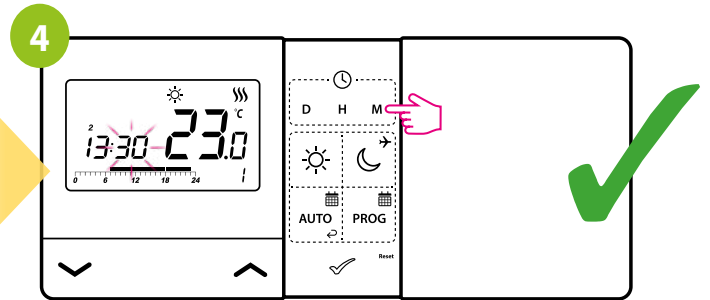

Pressing M button set the minutes.

6. Operation

6.1 Manual mode

There are two temperature setpoint levels at our disposal. In manual mode chosen setpoint temperature level is maintained permanently until user changes operation mode or set a different temperature for each level.

☀ - **Comfort Mode** - in this mode, the thermostat is to maintain a constant day temperature. When the temperature is set manually, e.g. 23°C, the thermostat maintains it until user switches to another operating mode or set a different temperature, e.g. 21°C.

🌙 - **Economic Mode** - in this mode, the thermostat is to maintain the reduced (night) temperature. When the temperature is set manually, e.g. 17°C, the thermostat maintains it until user switches to another mode or set a different temperature, e.g. 19°C.

6.1.1 Comfort mode

In the comfort temperature mode, the thermostat is to maintain a constant day temperature. The comfort temperature level is indicated by sun icon. To set the comfort temperature, see the steps below:

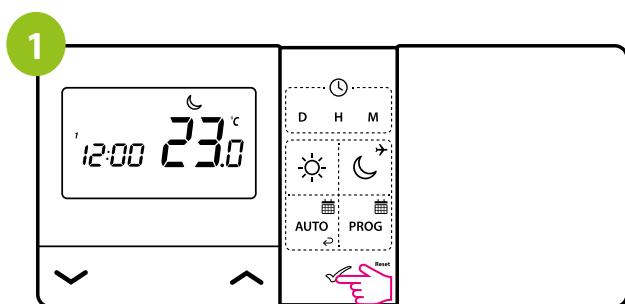

Press any button to highlight the display.

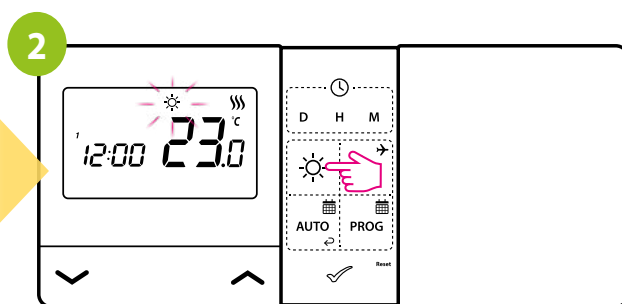

Press ☀ button to enter comfort temperature mode. The sun icon should be visible on the display.

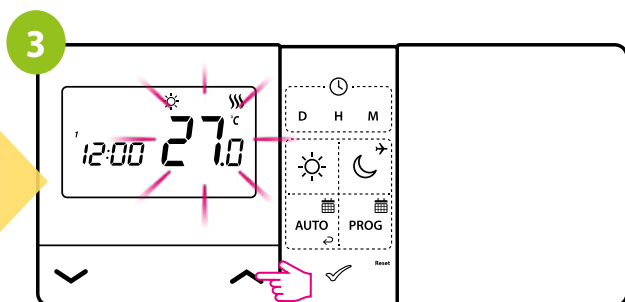

Using ^ or v buttons set new comfort temperature value.

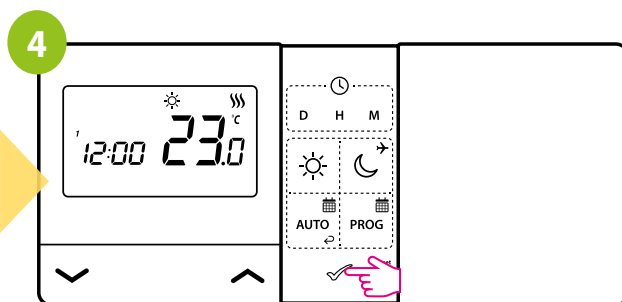

Confirm by ✓ button or wait until the thermostat will approve your choice itself and display the main screen.

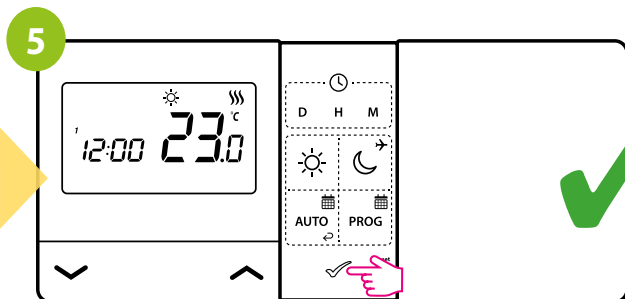

The thermostat will return to the main screen and display the actual changed temperature.

6.1.2 Economic mode

In the economic temperature mode, the thermostat is to maintain a reduced (night) temperature. This is to ensure a more economical operation of the heating system when, for example, you are away from home. The economic temperature level is indicated by the moon icon. To set the economic (night) temperature, see the steps below:

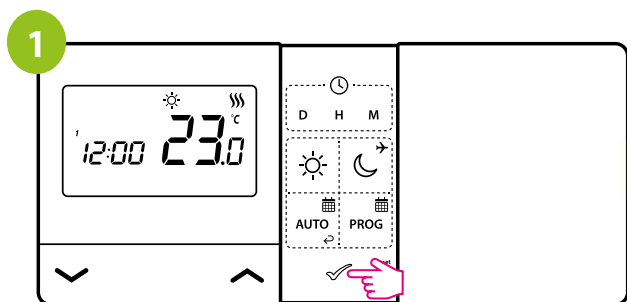

Press any button to highlight the display.

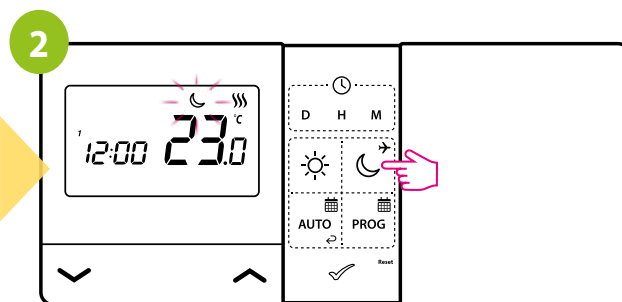

Press ☾ button to enter economic temperature mode.
The moon icon should be visible on the display.

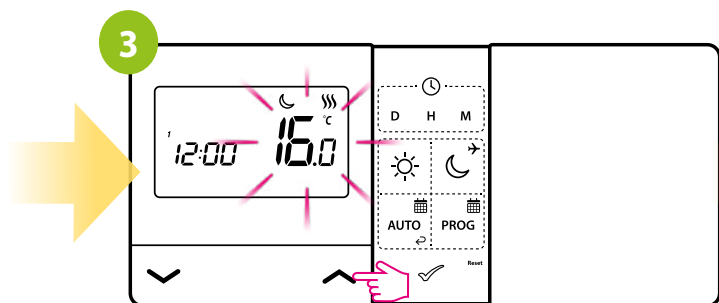

Using ^ or v buttons set new economic temperature value.

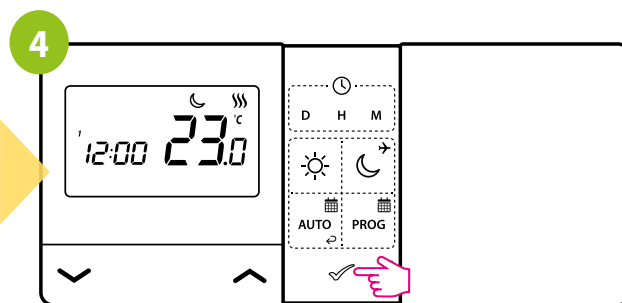

Confirm by ✓ button or wait until the thermostat will approve your choice itself and display the main screen.

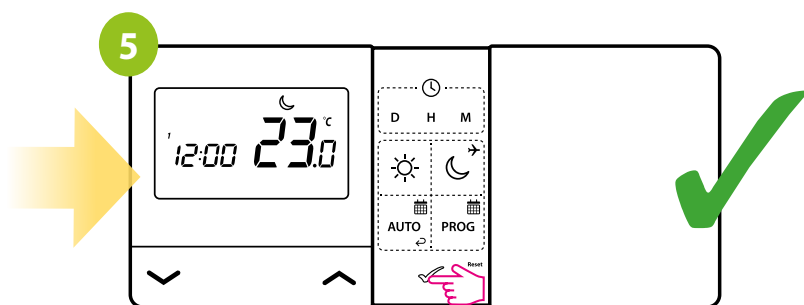

The thermostat will return to the main screen and display the actual changed temperature.

6.2 AUTO mode - schedule type 1

 - **AUTO Mode** - In the automatic mode, the thermostat maintains the set temperature according to the schedule selected by the user. You can choose from 2 types of schedule to manage the temperature during the week.

Comfort and Economic temperature setpoints works not only in manual mode but also for the first type schedule mode.

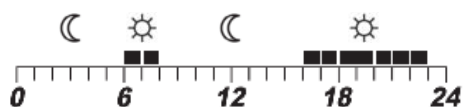

First type schedule mode is represented by timeline - 24 hours of a day. Empty „boxes” means hours where Economic (Moon) setpoint temperature will be maintained, black „boxes” means hours where Comfort (Sun) setpoint temperature will be maintained.

6.2.1 Default program settings (1-3)

Within first type schedule mode there are 9 programs available. Programs 0 to 3 are factory-defined programs that cannot be changed. In this chapter you will find detailed information on the built-in factory programs (1-3) in the E901. These are pre-programmed time settings for the comfort and economy temperature that can be assigned to a selected day. To set up the program, see the steps below. The black squares on the timeline (see the list of factory programs below) indicate the operating time for the comfort temperature mode, while the absence of them - for the economy temperature mode. Under the chart of each program, there is time (hour) when each mode is active. By default, program 1 is set for each day of the week.

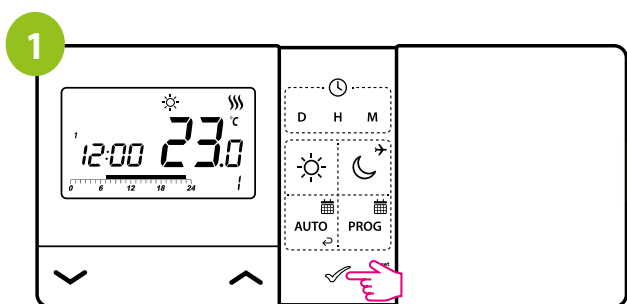

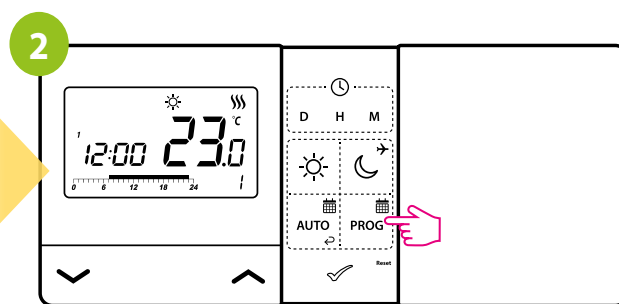

Press any button to highlight the display.



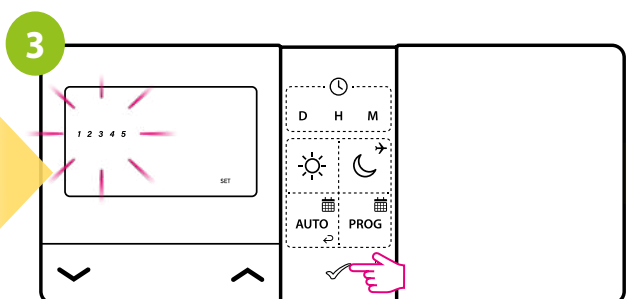

Press  button to enter the programming mode.

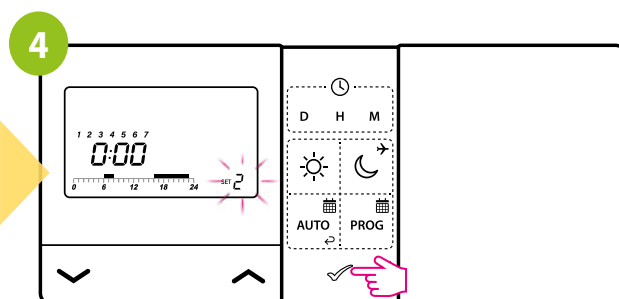

Select the week period using  or  buttons.
Confirm by  button.



Using  or  buttons choose program number (0-3).
Confirm by  button. The thermostat will proceed to program selection for the next time period.

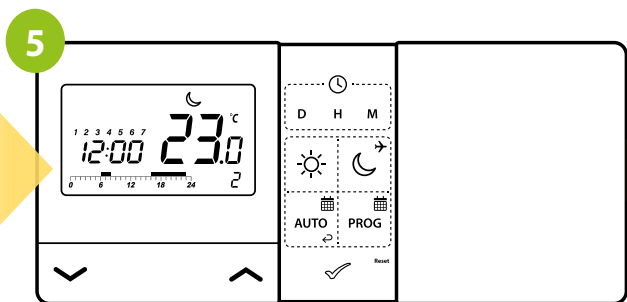

The thermostat will return to the main screen saving the set program. 

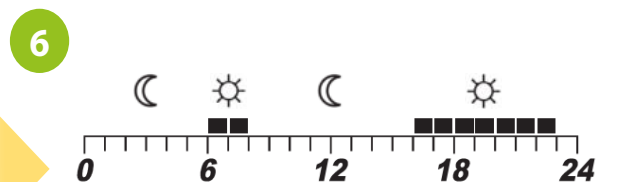

At the bottom of the display you can see the time line, i.e. the program sequence. Comfortable temperature mode (sun) is set from 6 to 8 and from 4 to 11 p.m.



PLEASE NOTE!

Programs should be set for all days of the week.

6.2.2 Choosing and programming (4-9) user programs

In order to program your own schedule its necessary to choose user program (4-9), because only user programs are editable. Then we must draw our own timeline using Sun/Moon buttons. Thermostat will be switching between two setpoint temperatures (Comfort and Economy) which are represented by Sun and Moon icons. Switching time is represented by timeline. See steps below how to programm your own schedule:

Example: below, program 4 will be defined for the MON - FR period with a comfort temperature from 8:00 a.m. to 4:00 p.m. and economic from 0:00 a.m. to 8:00 a.m. and 4:00 p.m. to 0:00 a.m. Programming starts from 0:00 a.m.

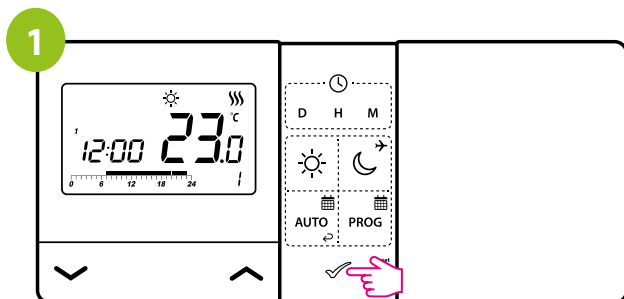

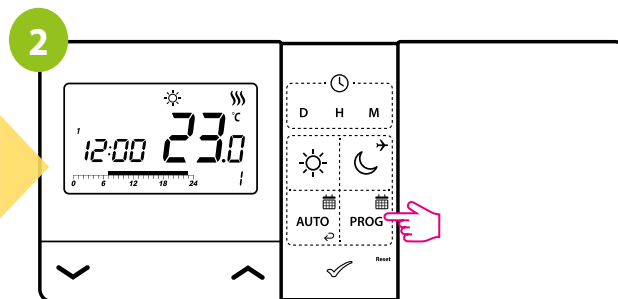

Press any button to highlight the display.



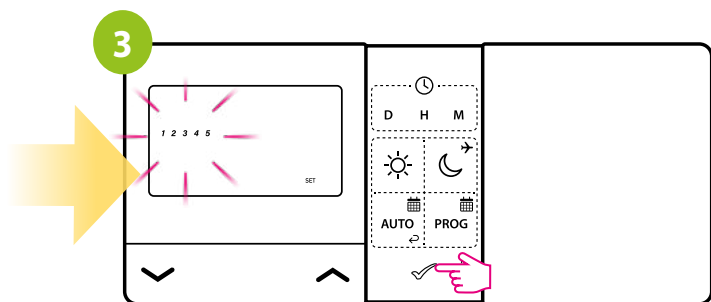

Press  button to enter the programming mode.

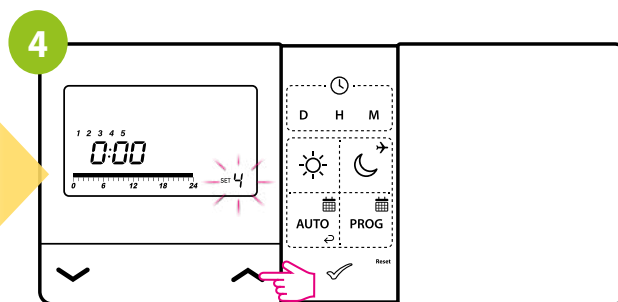

Select the week period (MON-FR) using  or  buttons. Confirm by  button.



Using  or  buttons choose program number 4.

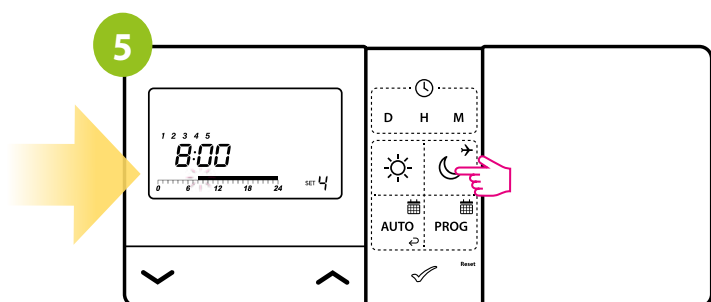

Use the button  several times to set the economic temperature until 8:00 am.

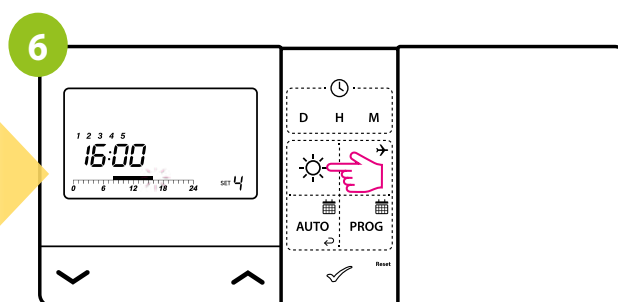

From 8:00 a.m. to 4:00 p.m. set comfort temperature by pressing several times  button.

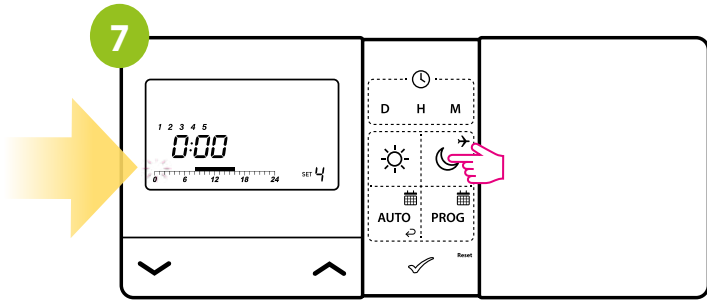

Then from 4:00 p.m. to 0:00 a.m. use the  button several times to set the economic temperature.

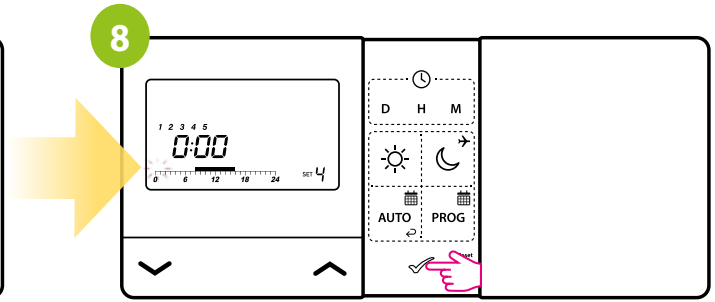

Confirm by  button.

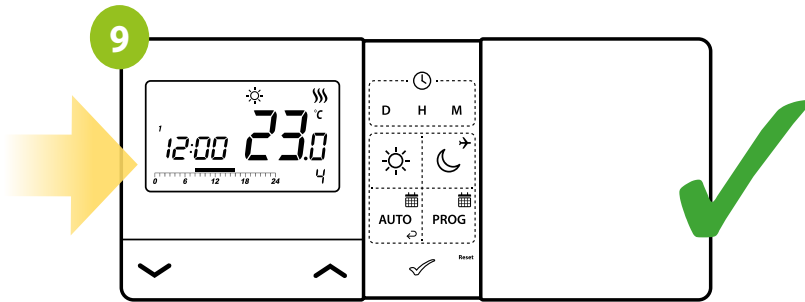

The thermostat will return to the main screen saving the set program.



Please note!

Programs 0, 1, 2, 3 are factory set and cannot be edited.

Programs 4 to 9 (user defined) are common to selected periods of the days of the week. This means that if one of the user-defined day programs is changed, the change will also apply to other days in the period.

6.2.3 Frost Protection program setting

Frost protection mode (program 0) protects heating system against freezing. It is recommended to set this program if you are planning a long winter trip or if you do not heat up for a long time. The thermostat will maintain a constant temperature of 7°C, thus reducing energy consumption to a minimum.

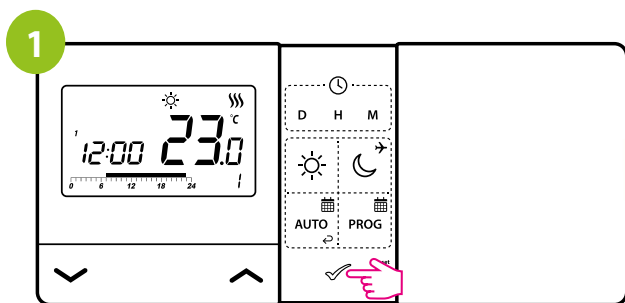

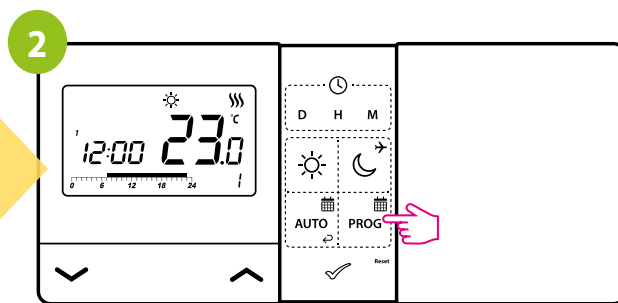

Press any button to highlight the display.



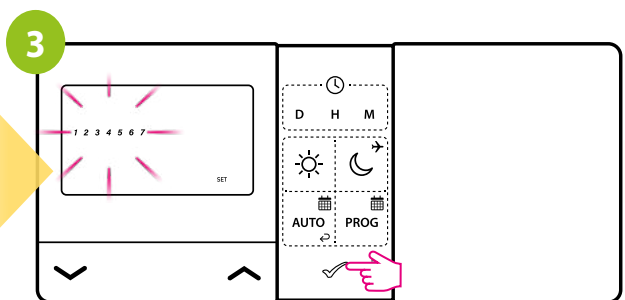

Press  button to enter the programming mode.

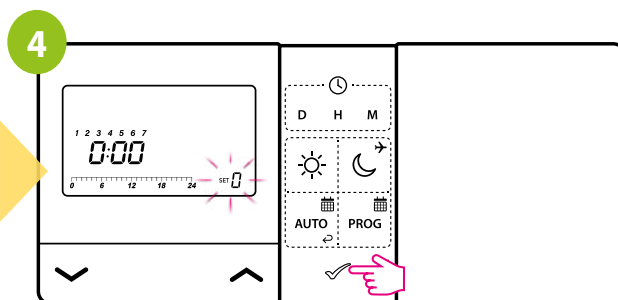

Select the week period using  or  buttons.
Confirm by  button.



Using  or  buttons choose program number 0.
Confirm by  button. The thermostat will proceed to program selection for the next time period.

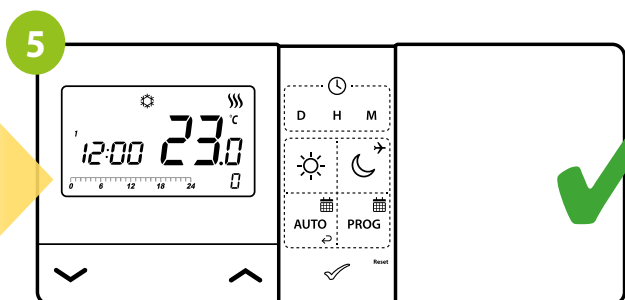

The thermostat will return to the main screen saving the set program. Snowflake -  icon will appear on the display.



PLEASE NOTE!

In the frost protection mode, the temperature setpoint can't be changed and it is maintained constantly at 7°C.

6.2.4 Temporary overwrite mode

When thermostat is running schedule (automatic mode) we can temporarily override it by new setpoint temperature:

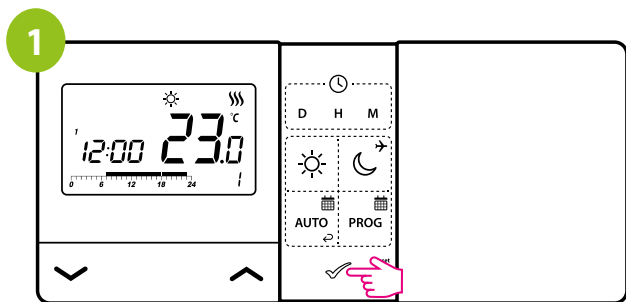

Press any button to highlight the display.

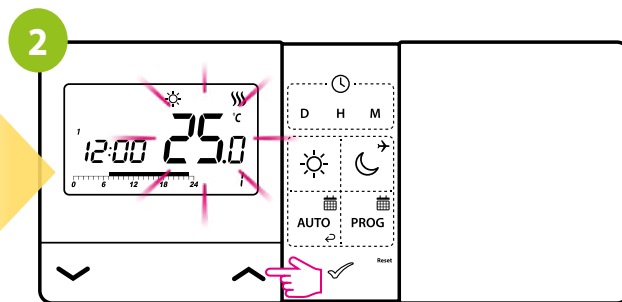

Use \wedge or \vee buttons to set the temperature.
Confirm by \checkmark button.

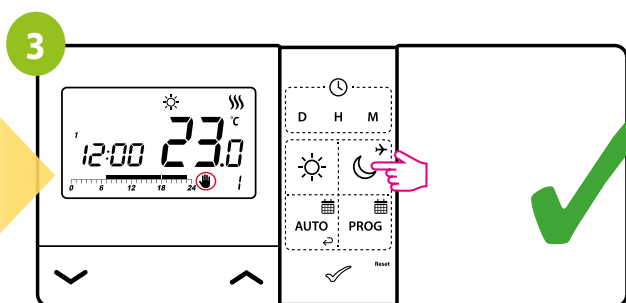

The display will show the „hand” symbol.

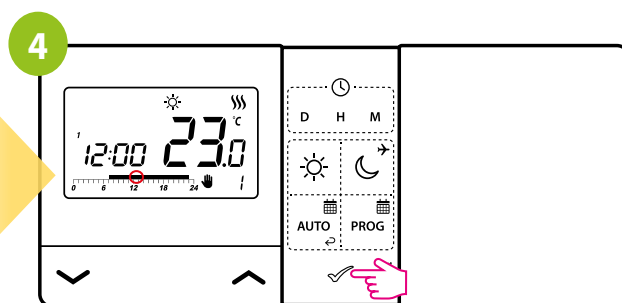

The overwritten temperature is maintained until the next
change forced by schedule.

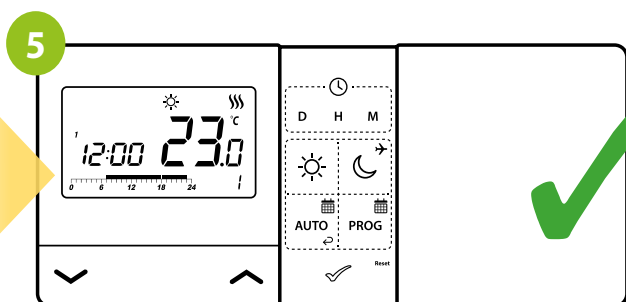

Then the „hand” symbol will disappear from the display
and the thermostat will return to the automatic mode.

6.3 AUTO mode - schedule type 2

 - **AUTO Mode** - In the automatic mode, the thermostat maintains the set temperature according to the schedule selected by the user. You can choose from 2 types of schedule to manage the temperature during the week.

Schedule type 2 is for those who need detailed schedule with more than 2 setpoint temperatures and more accurately timing (schedule type 1 is limited to switching between two setpoint temperatures at full hour switching points).

6.3.1 Switching between AUTO Mode type 1 and 2

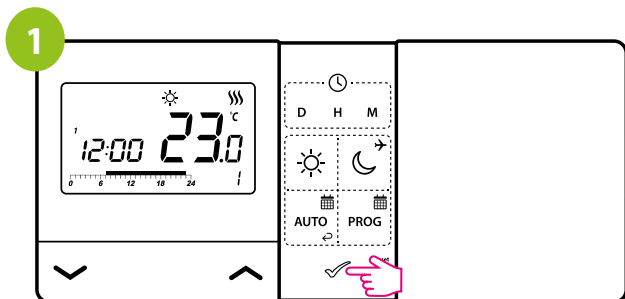

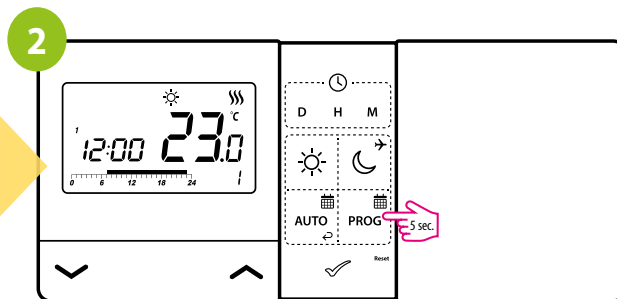

Press any button to highlight the display.

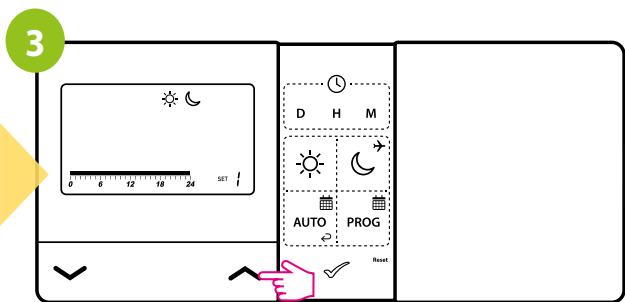

Press  button for 5 seconds to enter to the schedule programming selection mode.



Using  or  buttons choose the second type of schedule programming.

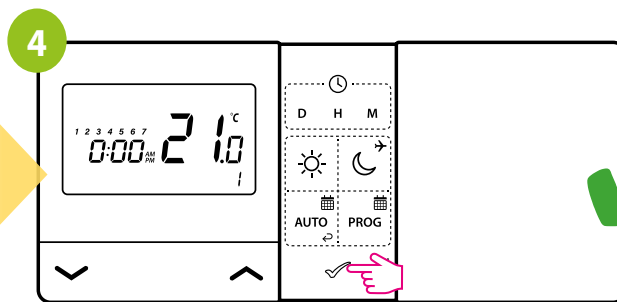

Confirm by  button. Thermostat will return to the main screen saving the second type of schedule programming. The timeline will also disappear.

6.3.2 Programming method of the AUTO mode - type 2

To set the second type of AUTO mode, please follow steps below:

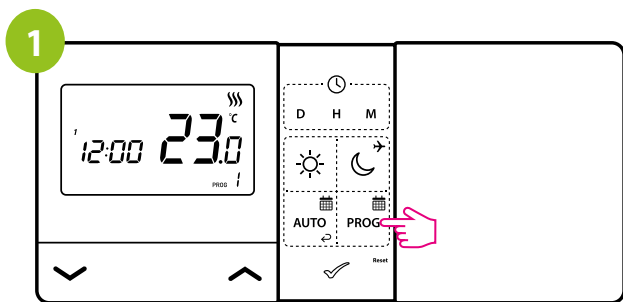

Press **PROG** button to enter the programming mode.

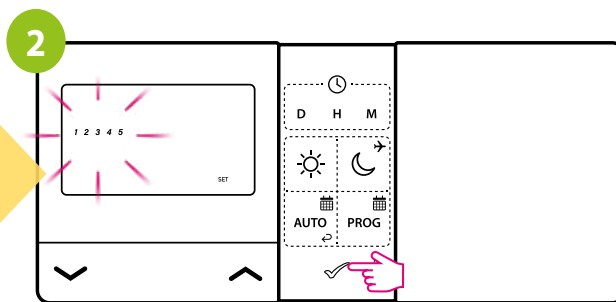

Select the week period using **^** or **v** buttons.
Confirm by **✓** button.

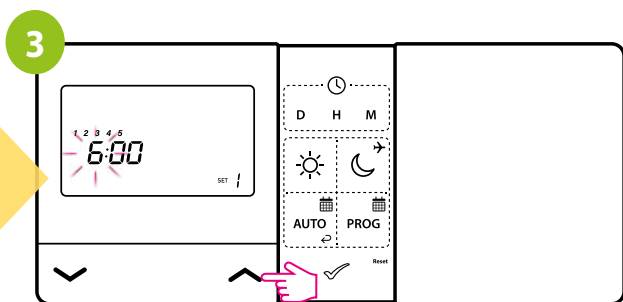

Using **^** or **v** buttons set the hour for the time period
and then after confirmation by **✓** button, set the minutes.
Confirm by **✓** button.

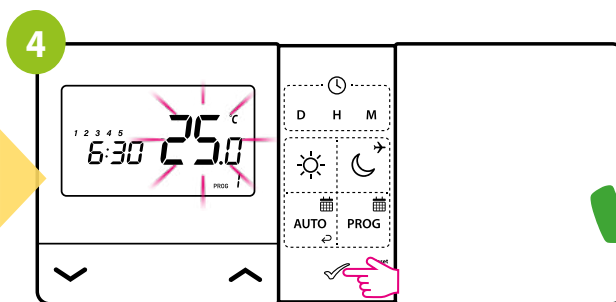

Use **^** or **v** buttons to set temperature setpoint.
Confirm by **✓** button. The thermostat will proceed to
program selection for the next time period
(a maximum of 6 time periods/switching points can be set).

6.3.3 Temporary overwrite mode

When thermostat is running schedule mode we can temporarily override it by setting new work mode or setpoint temperature:

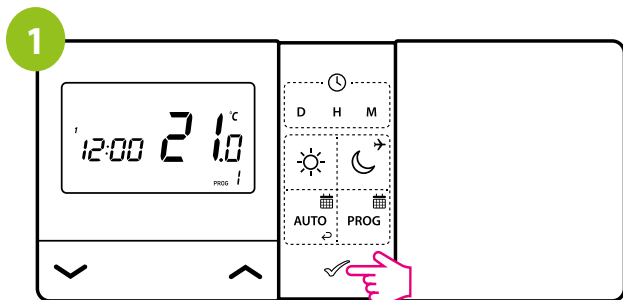

Press any button to highlight the display.

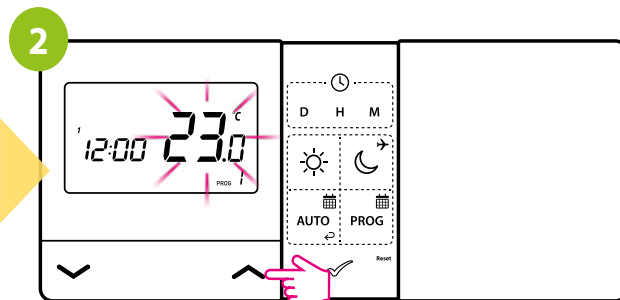

Using ^ or v buttons set temperature setpoint during active AUTO mode.

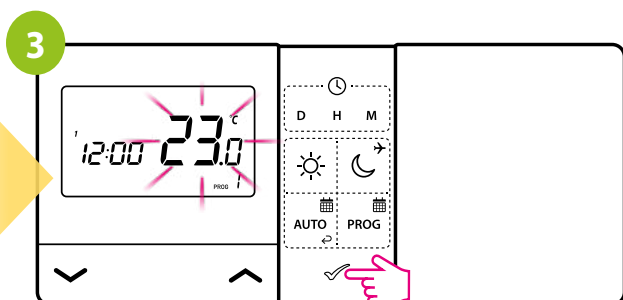

Confirm by ✓ button.

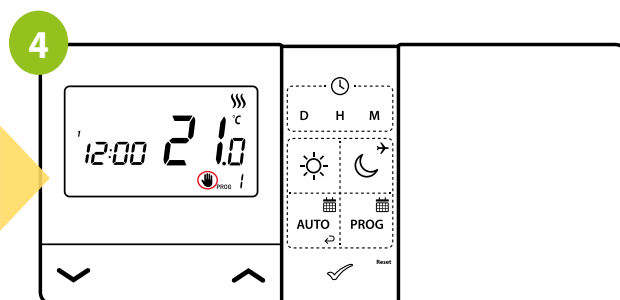

The hand icon will be displayed.
The temperature will be maintained until the next mode change in the program.

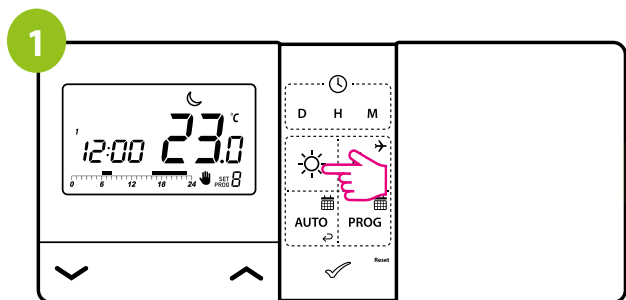

6.4 Party mode

In the party mode, the user can override schedule with comfort setpoint temperature by defined number of hours. To do this, follow the steps below:

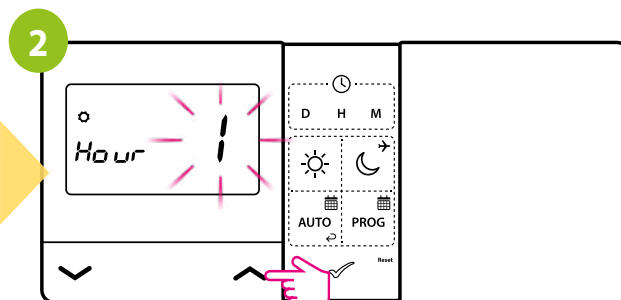

Hold the  button for 3 seconds.



Use  or  buttons to select the number of hours.

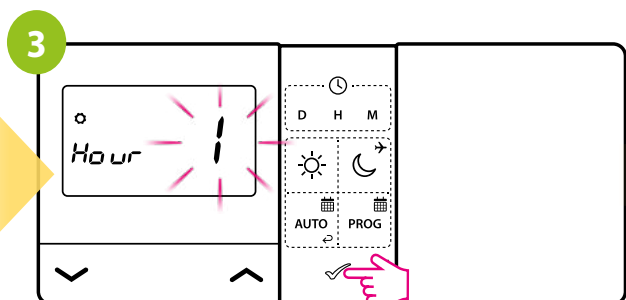

Confirm by  button.

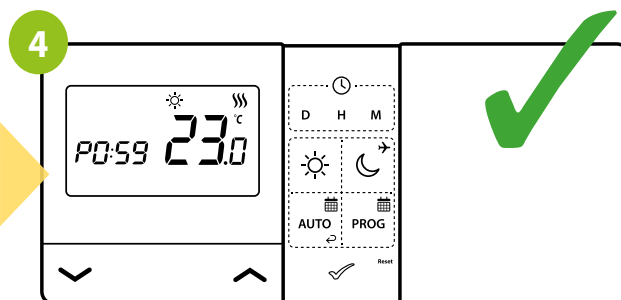



Comfort setpoint temperature will be maintained for defined number of hours. After that thermostat will go back to AUTO mode (schedule).

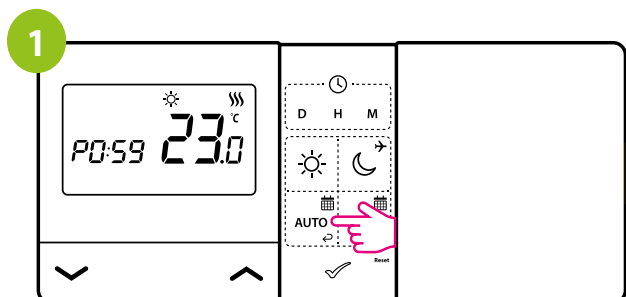

The maximum duration of party mode is 9 hours. The temperature setpoint does not change during this mode. When party mode is enabled, pressing SUN, MOON or AUTO button twice (or 3 times if backlight is OFF) will disable it and thermostat will go back to appropriate mode.

To cancel active party mode (example):



To cancel the function, press any button to turn on backlight and then press 2 times  button.

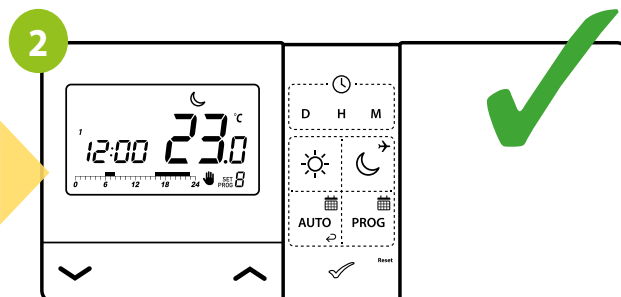

The thermostat will stop party mode and will return to schedule (Auto mode).

6.5 Holiday mode

Holiday mode is a special program temperature setpoint which thermostat will maintain for specified days. During holiday mode thermostat is maintaining frost protection setpoint temperature. How to set **HOLIDAY MODE**:

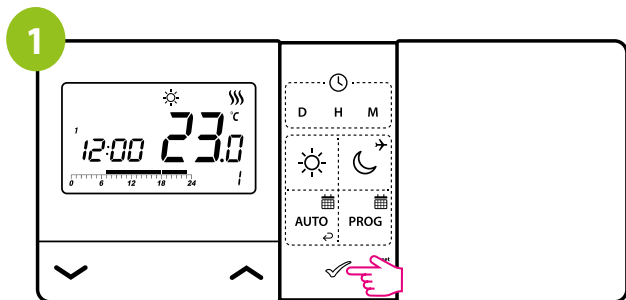

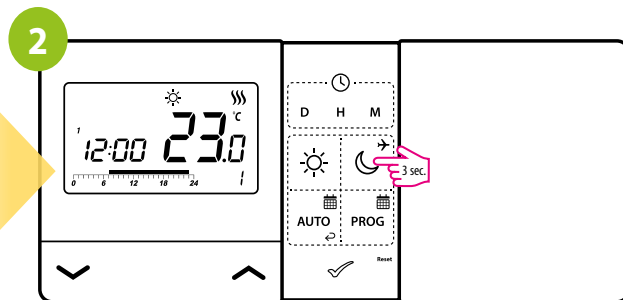

Press any button to highlight the display.

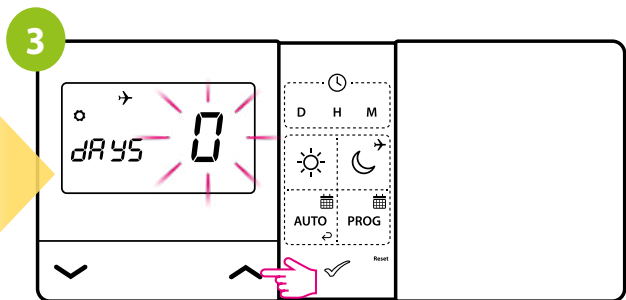

Press and hold  button for 3 seconds.



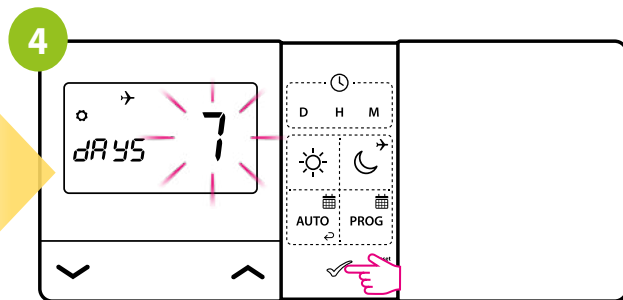

Use  or  buttons to select the day period.

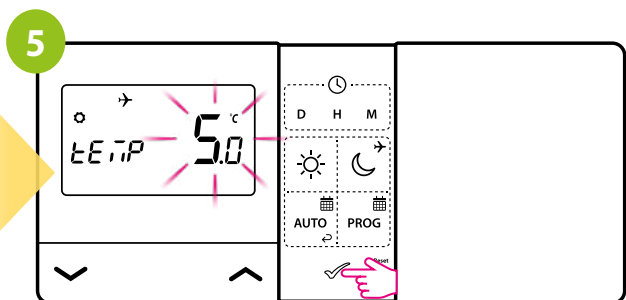

Confirm by  button.



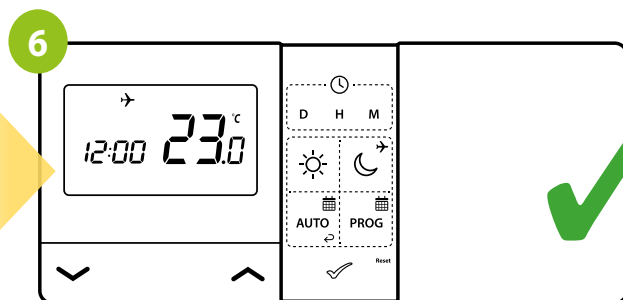

Use  or  buttons to set temperature setpoint for selected day period which thermostat will maintain.
Confirm by  button.

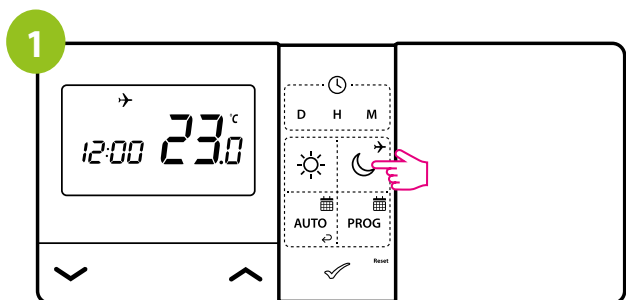

The thermostat is working in holiday mode. Plane icon is on the display.

TO STOP HOLIDAY MODE:



Press  button.

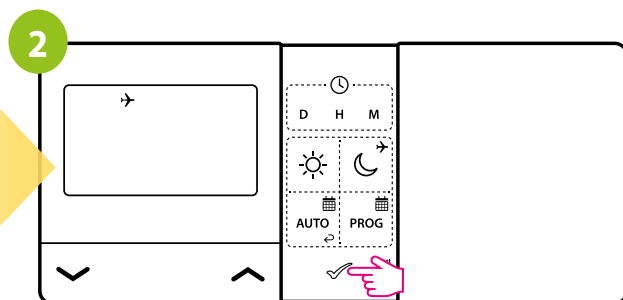

Confirm by  button.

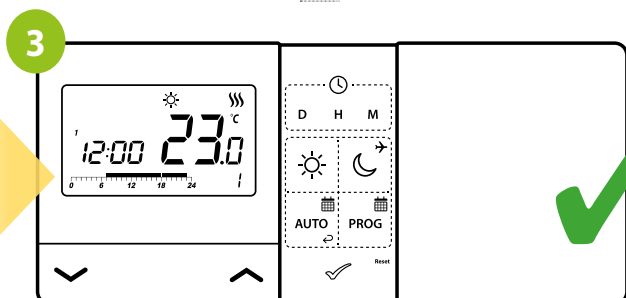

The thermostat will return to the previous mode.

7. Installer settings

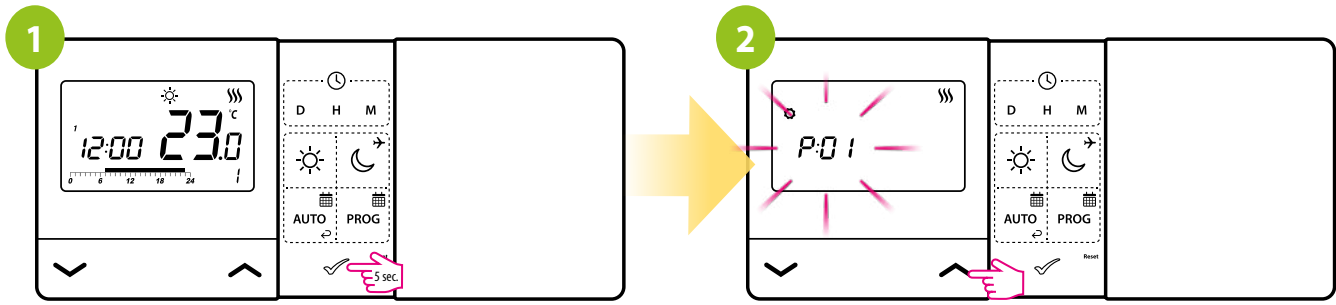

Press ✓ button for 5 seconds.

You are in the installer mode. Use ^ or v buttons to move between parameters. Enter the parameter by ✓ button. Edit the parameter using ^ or v button. Confirm the new parameter value with the ✓ button.

INSTALLER PARAMETERS:

Pxx	Function	Value	Description	Default value
P01	Heating/Cooling Selection		Cooling	
			Heating	
P02	Control method temperature	1	SPAN $\pm 0,25^{\circ}\text{C}$	1
		2	SPAN $\pm 0,5^{\circ}\text{C}$	
		3	TPI for Underfloor Heating	
		4	TPI for Radiators	
		5	TPI for Electrical Heating	
P03	Display temperature resolution	0,5°C	This parameter specifies the accuracy of the displayed (measured) temperature.	0,5°C
		0,1°C		
P04	Offset temperature	-3.5°C to +3.5°C	If the thermostat indicates wrong temperature, you can correct it by $\pm 3.5^{\circ}\text{C}$	0°C
P05	Relay type	NO	Normally Open type of relay	NO
		NC	Normally Closed type of relay	
P06	Clock format	24h	24 hour	24h
		12h	12 hour	
P07	Temperature Scale	°C	Celsius	°C
		°F	Fahrenheit	
P08	Minimum setpoint	5°C - 34,5°C	Minimum heating / cooling temperature that can be set	5°C
P09	Maximum setpoint	5,5°C - 35°C	Maximum heating / cooling temperature that can be set	35°C

Pxx	Function	Value	Description	Default value
P10	Key sound	NO	Off	YES
		YES	On	
P11	PIN Code	NO	Disabled	NO
		PIN	Enabled	
P12	Require a PIN to unlock the keys every time	NO	Function disabled	YES
		YES	Function enabled	
CLR	Clear settings factory reset	NO	No action	NO
		YES	Factory Reset	

8. User settings reset

There is a small hole to the right of the OK button. This is the reset button. Pressing the reset button will restore the default values in the user settings (i.e. time, schedule).

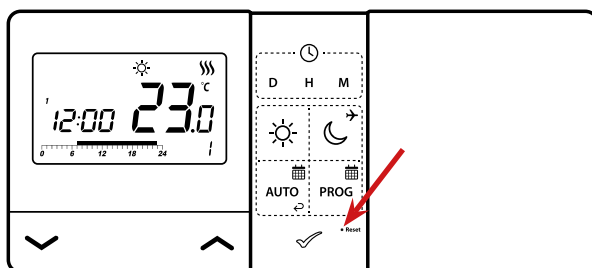

Please note:

Do not use a pencil to press the reset button as the graphite build-up on the stylus can short-circuit and damage the thermostat. In environments with very strong electrostatic discharge (+/- 8KV), the product may not function as under normal conditions. So the device may need to be reset.

9. Clear settings - factory reset

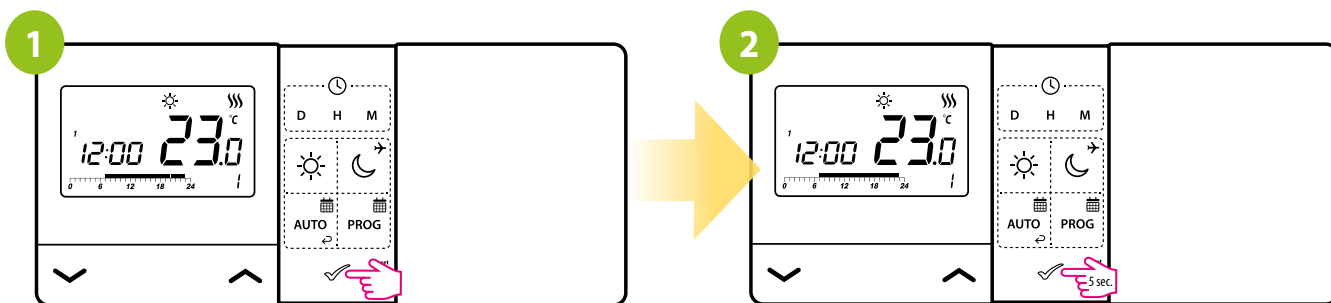

To perform factory reset (which will remove all user/installer settings), use the CLR parameter from installer parameters menu. After confirming the parameter, the thermostat will restore the default settings.

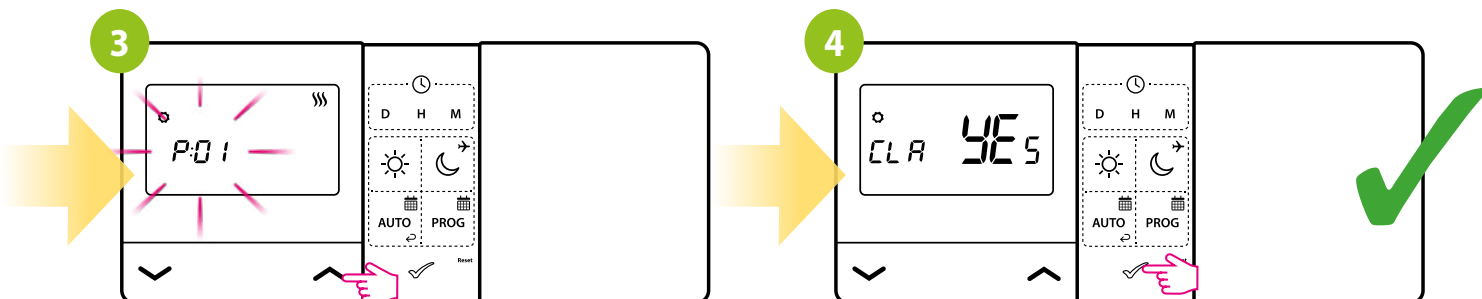

Press any button to highlight the display.

Press  button for 5 seconds.



Use  or  buttons to move to CLR parameter.

Confirm the new parameter value with the  button.

10. Cleaning and Maintenance

The **E901 thermostat** requires no special maintenance. Periodically, the outer casing can be wiped clean using a dry cloth (please DO NOT use solvents, polishes, detergents or abrasive cleaners, as these can damage the thermostat). There are no user serviceable parts within the unit; any servicing or repairs could only be carried out by **ENGO Controls** or their appointed agents.

11. Technical Informations

Transmitter's power supply	2 x AA batteries
Rating max	5 (3) A
Output signal	NO/COM relay
Temperature range	5 - 35°C
Display temperature accuracy	0.1°C or 0.5°C
Control algorithm	ITLC or Hysteresis: $\pm 0.25^{\circ}\text{C}$, Hysteresis: $\pm 0.5^{\circ}\text{C}$
Communication	Wired
Dimension [mm]	150 x 84 x 22

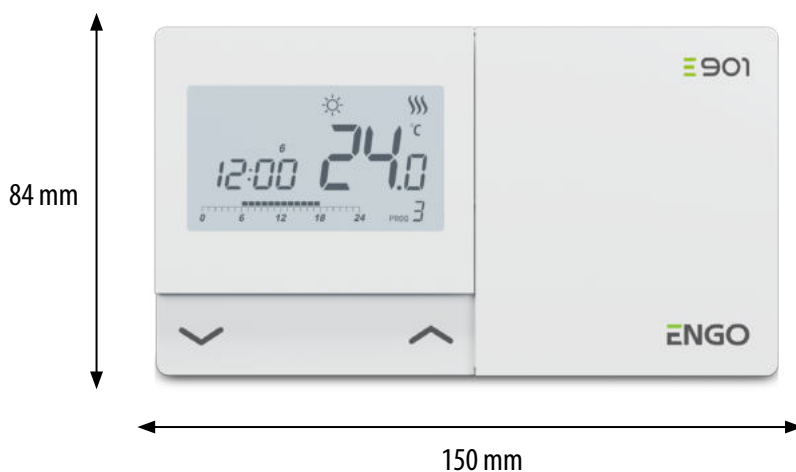

12. Warranty

ENGO Controls warrants this product to be free from any defects in material or workmanship and to perform as specified for a period of five years from the date of installation. ENGO Controls reserves the sole responsibility for breach of this warranty by repairing or replacing the defective product. This product includes software that matches the distributor's identification at the time of sale. The manufacturer / distributor provides a guarantee covering all functions and specifics of the product in accordance with this marking. The distributor's warranty does not cover the correct operation of the functions and features available as a result of a product software update.

<p>Customer Name:</p> <p>Customer Address:</p> <p>..... Post Code:</p> <p>Tel No: Email:</p>
<p>Company Name:</p> <p>Tel No: Email:</p> <p>Installation Date:</p> <p>Installer Name:</p> <p>Installer Signature:</p>



Producer:

Engo Controls S.C.
43-200 Pszczyna
3E Górnośląska St.
Poland

Distributor:

QL CONTROLS Sp z o.o. Sp. k.
43-262 Kobielice
4 Rolna St.
Poland

Ver. 1

Date of issue: II 2022

Power supply: 2xAA batteries

www.engocontrols.com